



OUTILLAGE DE SÉCURITÉ

ANTIDÉFLAGRANT ANTIMAGNÉTIQUE

NON SPARKING - NON MAGNÉTIQUE - SAFETYTOOLS



FABRICANT FRANÇAIS D'OUTILLAGE ANTIDÉFLAGRANT DEPUIS 1985

www.adf-safetytools.com

DOUILLES / CLIQUETS / ACCESSOIRES

SOCKETS / RATCHET / ACCESSORIES
 STECKSCHLÜSSEL-EINSÄTZE / RATSCHEN / ZUBEHÖR
 VASO / TRINQUETE / ACCESORIOS



5 ... 22

CLÉS / CLÉS MIXTES / CLÉS A FRAPPER / CLÉS A MOLETTE

WRENCHES / ADJUSTABLE WRENCHES / STRIKING WRENCHES / ADJUSTABLES END WRENCHES
 SCHLÜSSEL / RINGMAULSCHLÜSSEL / RINGSCHLAGSCHLÜSSEL / ROLLGABELSCHLÜSSEL
 LLAVE / LLAVE COMBINADA / LLAVE GOLPE / LLAVE DE CABEZA AJUSTABLE



23 ... 62

MASSES / MARTEAUX

HAMMERS SLEDGE / CLUB HAMMERS
 FÄUSTEL / HAMMERS
 ACOTILLO / MARTILLO



63 ... 66

BURINS / COINS / BROCHES

CHISELS / WEDGES / PUNCH
 MEISSEL / FLANSCHKEIL / SPLINTTREIBER
 CINCEL / CUNA / BOTADOR



67 ... 76

PINCES / PINCES MULTIPRISES / TENAILLES

PLIERS / PLIERS GROOVE JOINT / PLIERS CUTTING
 ZANGE / WASSERPUMPENZANGE / BEIBZANGE
 ALICATE / PINZA JUNTA ESTRILA / PINZA CORTADORA



77 ... 84

TOURNEVIS / TOURNEVIS PH / PZ / TORX

SCREWDRIVERS / SCREWDRIVERS PH / PZ / TORX
 SCHRAUBENDREHER / SCHRAUBENDREHER PH / PZ / TORX
 DESTORNILLADOR / DESTORNILLADOR PH / PZ / TORX



85 ... 88

GRATTOIRS / BROSSES / LIMES

SCRAPERS / BRUSHES / FILES
 SCHABER / BÜRSTE / KALK
 RASPADOR / CEPILLO / LIMA



89 ... 98

PELLES / PIOCHES / BÈCHES / HOUES / RATEAUX

SHOVELS / RAILROAD PICKS / EDGING SPADES / HOES / RAKES
 SCHAUFEL / KREUZHACKE / SPATEN / HAUE / RECHEN
 PALA / PICO DE FERROCARRIL / AZADA / AZADON / RASTRILLO



99 ... 102

EXTRACTEURS / SERRES-JOINTS / SEAUX / AIGUILLES

ARM PULLER / SCREW CLAMP / BUCKETS / NEEDLES
 RADABZIEHER-DREJARMIG / SCHRAUBZWINGE / EIMER / NADEL
 TIRADOR / PRENSA / BLADE / AGUJA



103 ... 107

DOUILLES / CLIQUETS / ACCESSOIRES

SOCKETS / RATCHET / ACCESSORIES

STECKSCHLÜSSEL-EINSÄTZE / RATSCHEN / ZUBEHÖR

VASO / TRINQUETE / ACCESORIOS



ANTIDÉFLAGRANT
ANTIMAGNÉTIQUE
SAFETYTOOLS

www.adf-safetytools.com

ANTIDÉFLAGRANT
ANTIMAGNÉTIQUE
SAFETYTOOLS

www.adf-safetytools.com

DOUILLE 1/4"

1/4" socket / 1/4" steckschlüssel-einsätze / Vaso 1/4"

S mm	L mm	C inch	Alliage / Alloy	
			Al-Br	Be-Cu
4	25	1/4"	026704	013904
5	25	1/4"	026705	013905
6	25	1/4"	026706	013906
7	25	1/4"	026707	013907
8	25	1/4"	026708	013908
9	25	1/4"	026709	013909
10	25	1/4"	026710	013910
11	25	1/4"	026711	013911
12	26	1/4"	026712	013912
13	26	1/4"	026713	013913
14	26	1/4"	026714	013914
15	27	1/4"	026715	013915
16	27	1/4"	026716	013916
17	27	1/4"	026717	013917
18	27	1/4"	026718	013918
19	27	1/4"	026719	013919

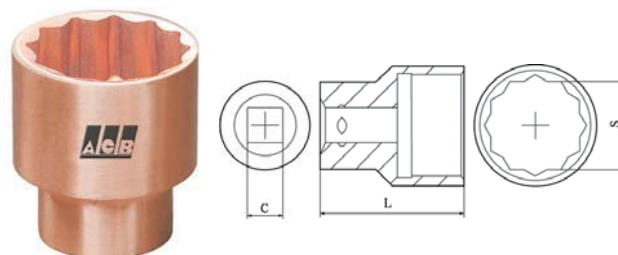

S inch	L mm	C inch	Alliage / Alloy	
			Al-Br	Be-Cu
5/32"	25	1/4"	036302	032502
3/16"	25	1/4"	036305	032505
7/32"	25	1/4"	036308	032508
1/4"	25	1/4"	036311	032511
9/32"	25	1/4"	036314	032514
5/16"	25	1/4"	036317	032517
11/32"	25	1/4"	036320	032520
3/8"	25	1/4"	036323	032523
7/16"	25	1/4"	036326	032526
1/2"	26	1/4"	036329	032529

DOUILLE 3/8"

1/4" socket / 1/4" steckschlüssel-einsätze / Vaso 1/4"

S mm	L mm	C inch	Alliage / Alloy	
			Al-Br	Be-Cu
5	28	3/8"	037405	037305
5,5	28	3/8"	037455	037355
6	28	3/8"	037406	037306
7	28	3/8"	037407	037307
8	28	3/8"	037408	037308
9	28	3/8"	037409	037309
10	32	3/8"	037410	037310
11	32	3/8"	037411	037311
12	32	3/8"	037412	037312
13	32	3/8"	037413	037313
14	32	3/8"	037414	037314
15	32	3/8"	037415	037315
16	32	3/8"	037416	037316
17	32	3/8"	037417	037317
19	32	3/8"	037419	037319
20	32	3/8"	037420	037320

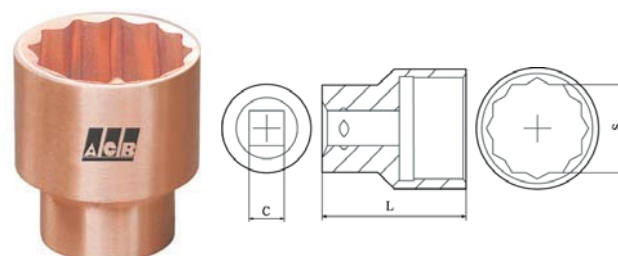

S inch	L mm	C inch	Alliage / Alloy	
			Al-Br	Be-Cu
5/16"	28	3/8"	033106	032906
3/8"	28	3/8"	033109	032909
7/16"	32	3/8"	033112	032912
1/2"	32	3/8"	033115	032915
9/16"	32	3/8"	033118	032918
5/8"	32	3/8"	033124	032924
11/16"	32	3/8"	033127	032927
3/4"	32	3/8"	033130	032930
13/16"	35	3/8"	033136	032936
7/8"	35	3/8"	033139	032939



DOUILLE 1/2"

1/2" socket / 1/2" steckschlüssel-einsätze / Vaso 1/2"

S mm	L mm	C inch	Alliage / Alloy	
			Al-Br	Be-Cu
6	40	1/2"	026806	014006
7	40	1/2"	026807	014007
8	40	1/2"	026808	014008
9	40	1/2"	026809	014009
10	40	1/2"	026810	014010
11	40	1/2"	026811	014011
12	40	1/2"	026812	014012
13	40	1/2"	026813	014013
14	40	1/2"	026814	014014
15	40	1/2"	026815	014015
16	40	1/2"	026816	014016
17	40	1/2"	026817	014017
18	42	1/2"	026818	014018
19	42	1/2"	026819	014019
20	42	1/2"	026820	014020
21	43	1/2"	026821	014021
22	43	1/2"	026822	014022
23	43	1/2"	026823	014023
24	43	1/2"	026824	014024
25	43	1/2"	026825	014025
26	43	1/2"	026826	014026
27	46	1/2"	026827	014027
28	46	1/2"	026828	014028
29	46	1/2"	026829	014029
30	46	1/2"	026830	014030
32	46	1/2"	026832	014032
34	46	1/2"	026834	014034
36	46	1/2"	026836	014036

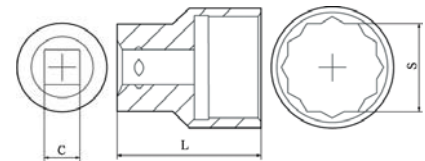

S inch	L mm	C inch	Alliage / Alloy	
			Al-Br	Be-Cu
5/16"	40	1/2"	036406	032606
3/8"	40	1/2"	036409	032609
7/16"	40	1/2"	036412	032612
1/2"	40	1/2"	036415	032615
9/16"	40	1/2"	036418	032618
5/8"	40	1/2"	036424	032624
11/16"	40	1/2"	036427	032627
3/4"	42	1/2"	036430	032630
13/16"	43	1/2"	036436	032636
7/8"	43	1/2"	036439	032639
15/16"	43	1/2"	036442	032642
1"	43	1/2"	036445	032645
1-1/16"	46	1/2"	036448	032648
1-1/4"	46	1/2"	036454	032654

ANTIDÉFLAGRANT
ANTIMAGNÉTIQUE
SAFETYTOOLS

www.adf-safetytools.com

DOUILLE 3/4"

3/4" socket / 3/4" steckschlüssel-einsätze / Vaso 3/4"

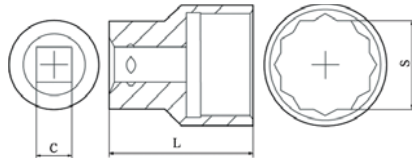

S mm	L mm	C inch	Alliage / Alloy	
			Al-Br	Be-Cu
16	50	3/4"	026916	014116
17	50	3/4"	026917	014117
19	50	3/4"	026919	014119
20	50	3/4"	026920	014120
21	55	3/4"	026921	014121
22	55	3/4"	026922	014122
23	55	3/4"	026923	014123
24	55	3/4"	026924	014124
25	55	3/4"	026925	014125
26	55	3/4"	026926	014126
27	55	3/4"	026927	014127
28	55	3/4"	026928	014128
29	55	3/4"	026929	014129
30	60	3/4"	026930	014130
31	60	3/4"	026931	014131
32	60	3/4"	026932	014132
34	60	3/4"	026934	014134
35	60	3/4"	026935	014135
36	60	3/4"	026936	014136
37	60	3/4"	026937	014137
38	60	3/4"	026938	014138
39	60	3/4"	026939	014139
40	60	3/4"	026940	014140
41	65	3/4"	026941	014141
42	65	3/4"	026942	014142
43	65	3/4"	026943	014143
44	65	3/4"	026944	014144
45	65	3/4"	026945	014145
46	65	3/4"	026946	014146
47	65	3/4"	026947	014147
48	65	3/4"	026948	014148
49	65	3/4"	026949	014149
50	65	3/4"	026950	014150



www.adf-safetytools.com



S inch	L mm	C inch	Alliage / Alloy	
			Al-Br	Be-Cu
3/4"	50	3/4"	036502	032702
13/16"	55	3/4"	036505	032705
7/8"	55	3/4"	036508	032708
15/16"	55	3/4"	036511	032711
1"	55	3/4"	036514	032714
1-1/16"	55	3/4"	036517	032717
1-1/8"	55	3/4"	036520	032720
1-3/16"	60	3/4"	036523	032723
1-1/4"	60	3/4"	036526	032726
1-5/16"	60	3/4"	036529	032729
1-3/8"	60	3/4"	036532	032732
1-7/16"	60	3/4"	036535	032735
1-1/2"	60	3/4"	036538	032738
1-5/8"	65	3/4"	036541	032741
1-3/4"	65	3/4"	036544	032744
1-13/16"	65	3/4"	036547	032747
1-7/8"	65	3/4"	036550	032750
2"	70	3/4"	036553	032753



DOUILLE 1"

1" socket / 1" steckschlüssel-einsätze / Vaso 1"

S mm	L mm	C inch	Alliage / Alloy	
			Al-Br	Be-Cu
16	60	1"	027016	014216
17	60	1"	027017	014217
19	60	1"	027019	014219
22	60	1"	027022	014222
24	60	1"	027024	014224
30	60	1"	027030	014230
32	60	1"	027032	014232
36	60	1"	027036	014236
41	70	1"	027041	014241
42	70	1"	027042	014242
46	75	1"	027046	014246
50	75	1"	027050	014250
55	80	1"	027055	014255
60	85	1"	027060	014260
65	90	1"	027065	014265
70	90	1"	027070	014270
75	95	1"	027075	014275
80	95	1"	027080	014280
85	95	1"	027085	014285
90	95	1"	027090	014290
95	95	1"	027095	014295
100	95	1"	027099	014299

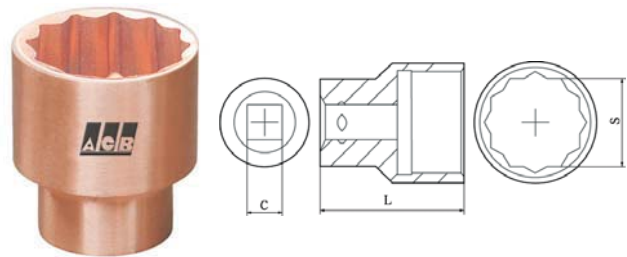

S inch	L mm	C inch	Alliage / Alloy	
			Al-Br	Be-Cu
1-1/16"	55	1"	033202	032802
1-1/8"	55	1"	033205	032805
1-3/16"	60	1"	033208	032808
1-1/4"	60	1"	033211	032811
1-5/16"	60	1"	033214	032814
1-3/8"	60	1"	033217	032817
1-7/16"	65	1"	033220	032820
1-1/2"	65	1"	033223	032823
1-5/8"	70	1"	033226	032826
1-7/8"	75	1"	033229	032829
2"	75	1"	033232	032832
2-1/4"	80	1"	033235	032835
2-1/2"	90	1"	033238	032838
2-3/4"	90	1"	033241	032841
3"	95	1"	033244	032844



DOUILLE 1/2" - 3/4" SÉRIE IMPACT

ANTIDÉFLAGRANT
ANTIMAGNÉTIQUE
SAFETYTOOLS

www.adf-safetytools.com

DOUILLE 1/2" SÉRIE IMPACT

1/2" socket / 1/2" steckschlüssel-einsätze / Vaso 1/2"

S inch	L mm	C inch	Alliage / Alloy	
			Al-Br	Be-Cu
11	40	1/2"	039311	033411
12	40	1/2"	039312	033412
13	40	1/2"	039313	033413
14	40	1/2"	039314	033414
15	40	1/2"	039315	033415
16	40	1/2"	039316	033416
17	40	1/2"	039317	033417
18	40	1/2"	039318	033418
19	40	1/2"	039319	033419
20	40	1/2"	039320	033420
21	40	1/2"	039321	033421
22	40	1/2"	039322	033422
23	40	1/2"	039323	033423
24	45	1/2"	039324	033424
25	45	1/2"	039325	033425

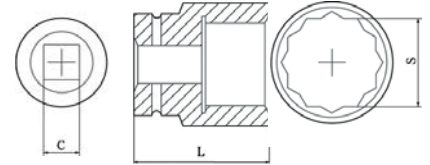

S inch	L mm	C inch	Alliage / Alloy	
			Al-Br	Be-Cu
26	45	1/2"	039316	033426
27	45	1/2"	039327	033527
28	45	1/2"	039328	033528
29	50	1/2"	039329	033529
30	50	1/2"	039330	033530
32	50	1/2"	039332	033532
34	50	1/2"	039334	033534
36	55	1/2"	039336	033536

DOUILLE 1" SÉRIE IMPACT

DOUILLE 3/4" SÉRIE IMPACT

3/4" socket / 3/4" steckschlüssel-einsätze / Vaso 3/4"

S inch	L mm	C inch	Alliage / Alloy	
			Al-Br	Be-Cu
17	50	3/4"	039117	033517
18	50	3/4"	039118	063518
19	50	3/4"	039119	033519
20	50	3/4"	039120	033520
21	50	3/4"	039121	039121
22	50	3/4"	039122	039122
23	50	3/4"	039123	039123
24	50	3/4"	039124	033524
25	50	3/4"	039125	039125
26	53	3/4"	039126	039126
27	53	3/4"	039127	033527
28	53	3/4"	039128	033528
29	53	3/4"	039129	033529
30	53	3/4"	039130	033530
32	56	3/4"	039132	033532

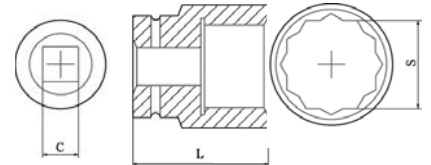

S inch	L mm	C inch	Alliage / Alloy	
			Al-Br	Be-Cu
34	56	3/4"	039134	033534
36	56	3/4"	039136	033536
40	60	3/4"	039140	033540
41	60	3/4"	039141	033541
46	60	3/4"	039146	033546
50	70	3/4"	039150	033550
55	75	3/4"	039155	033555
60	75	3/4"	039160	033560
65	75	3/4"	039165	33565
70	80	3/4"	039170	033570

ANTIDÉFLAGRANT
ANTIMAGNÉTIQUE
SAFETYTOOLS



DOUILLE 1" SÉRIE IMPACT

1" socket / 1" steckschlüssel-einsätze / Vaso 1"

S inch	L mm	C inch	Alliage / Alloy	
			Al-Br	Be-Cu
19	55	1"	039219	033619
21	55	1"	039221	033621
22	55	1"	039222	033622
24	55	1"	039224	033624
26	55	1"	039226	033626
27	55	1"	039227	033627
29	60	1"	039229	033629
30	60	1"	039230	033630
32	60	1"	039232	033632
34	60	1"	039234	033634
35	60	1"	039235	033635
36	60	1"	039236	033636
38	65	1"	039238	033638
41	70	1"	039241	033641
46	75	1"	039246	033646

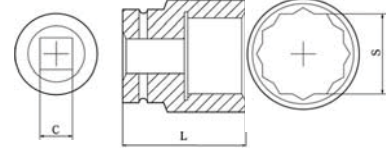

S inch	L mm	C inch	Alliage / Alloy	
			Al-Br	Be-Cu
50	75	1"	039250	033650
52	75	1"	039252	033652
55	75	1"	039255	033655
58	85	1"	039258	033658
60	85	1"	039260	033660
65	85	1"	039265	033665
70	90	1"	039270	033670
75	90	1"	039275	033675
80	90	1"	039280	033680
85	90	1"	039285	033685
90	100	1"	039290	033690
95	100	1"	039295	033695





CLIQUET RÉVERSIBLE

ANTIDÉFLAGRANT
ANTIMAGNÉTIQUE
SAFETYTOOLS

www.adf-safetytools.com

CLIQUET RÉVERSIBLE

Reversible ratchet wrench / Reversible knarre / Llave Trinquete

C inch	L mm	H mm	Alliage / Alloy	
			Al-Br	Be-Cu
1/4"	125	28	026500	013700
3/8"	125	28	026501	013701
1/2"	245	43	026502	013702
3/4"	300	57	026503	013703
1"	550	64	026505	013705

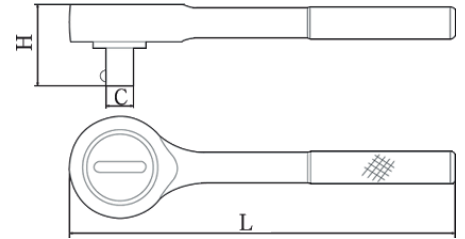

CLIQUET RÉVERSIBLE

CLIQUET RÉVERSIBLE

Reversible ratchet wrench / Reversible knarre / Llave Trinquete

C inch	L mm	Alliage / Alloy	
		Al-Br	Be-Cu
1/4"	200	082402	078002
3/8"	200	082406	078006
1/2"	250	082408	078008
3/4"	300	085410	078010
1"	300	085412	078012

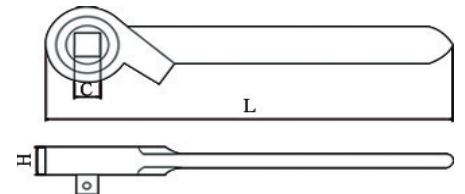

TÊTE DE CLIQUET REVERSIBLE

TÊTE DE CLIQUET REVERSIBLE

Ratchet wrench with handle / Knarre / Llave Trinquete

C inch	L mm	H mm	Alliage / Alloy	
			Al-Br	Be-Cu
3/4"	160	63	082303	077903
1"	180	80	082305	077905

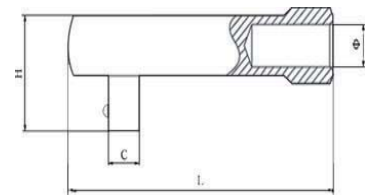

CARDAN UNIVERSEL

CARDAN UNIVERSEL

Universal joint / Kardangelenke / Connexion Universal

C inch	L mm	Alliage / Alloy	
		Al-Br	Be-Cu
1/4"			014601 ?
3/8"		027401	
1/2"	50	027402	014602
3/4"	60	027403	014603
1"	70	027404	014604

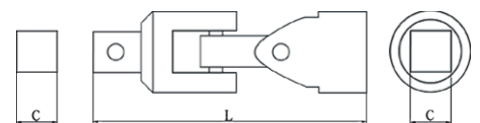

ANTIDÉFLAGRANT
ANTIMAGNÉTIQUE
SAFETYTOOLS



MANCHE À CLIQUET 6 PANS

Ratchet wrench / Schaltklinke / Llave del trinquete

C inch	L mm	L ₁ mm	Alliage / Alloy	
			Al-Br	Be-Cu
17	290	35	026517	013717
19	300	35	026519	013719
22	320	38	026522	013722
24	329	39	026524	013724
27	380	39	026527	013727
30	433	42	026530	013730
32	435	42	026532	013732
36	487	43	026536	013736

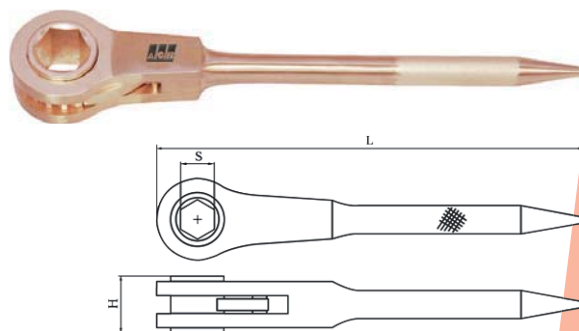

MANCHE À CLIQUET 12 PANS

MANCHE À CLIQUET 12 PANS

Ratchet wrench / Schaltklinke / Llave del trinquete

C inch	L mm	L ₁ mm	Alliage / Alloy	
			Al-Br	Be-Cu
19	300	35	026519	013719
22	270	50	023922	009722
24	280	53	023924	009724
27	290	56	023927	009727
30	300	58	023930	009730
32	310	60	023932	009732
36	320	65	023936	009736
38	320	65	026538	013738

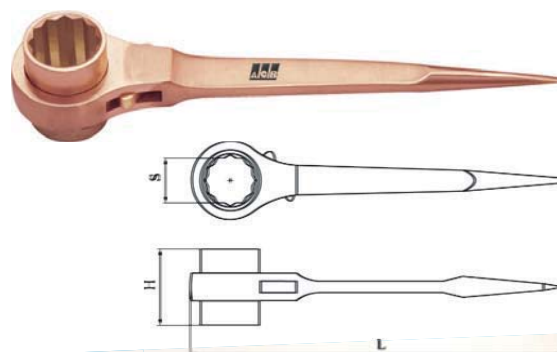

ANTIDÉFLAGRANT
ANTIMAGNÉTIQUE
SAFETYTOOLS

www.adf-safetytools.com

RALLONGE

Extension bar / Verlängerungen / Barra de Extension

C inch	L mm	Alliage / Alloy	
		Al-Br	Be-Cu
1/4"	75	027105	014305
3/8"	75	027108	014308
3/8"	150	027109	014309
1/2"	100	027112	014312
1/2"	125	027113	014313
1/2"	200	027114	014314
1/2"	250	027116	014316
3/4"	200	027120	014320
1"	200	027125	014325

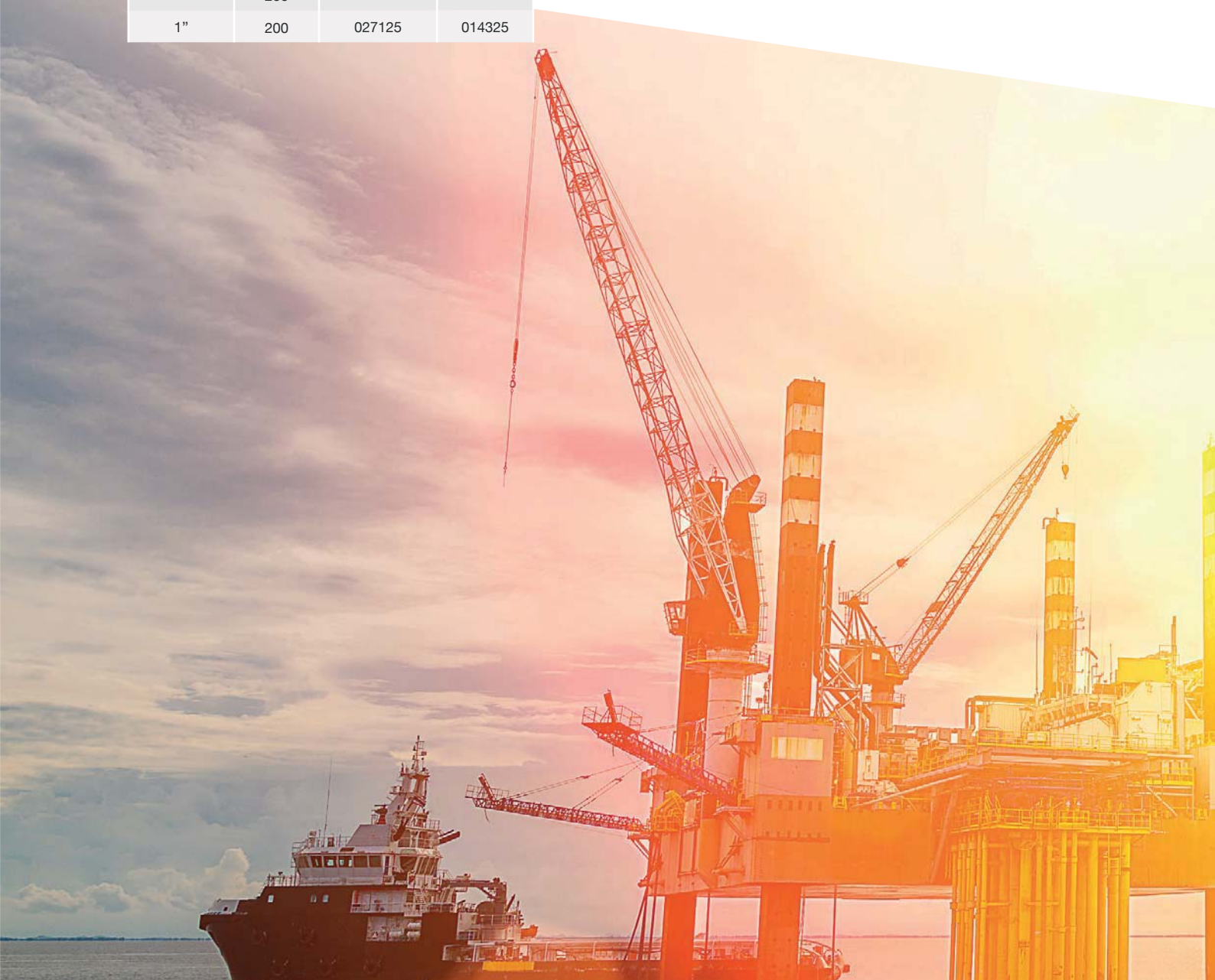
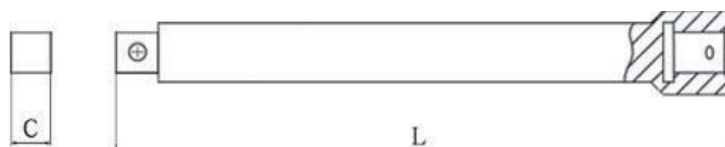

**ANTIDÉFLAGRANT
ANTIMAGNÉTIQUE
SAFETYTOOLS**



POIGNÉE COULISSANTE

Sliding T bar / T - Gleitgriff / Barra Deslizante

C inch	L mm	H mm	Ø mm	Alliage / Alloy	
				Al-Br	Be-Cu
1/2"	250	39	13	026602	013802
3/4"	350	54	19	026603	013803
1"	400	62	21	026604	013804

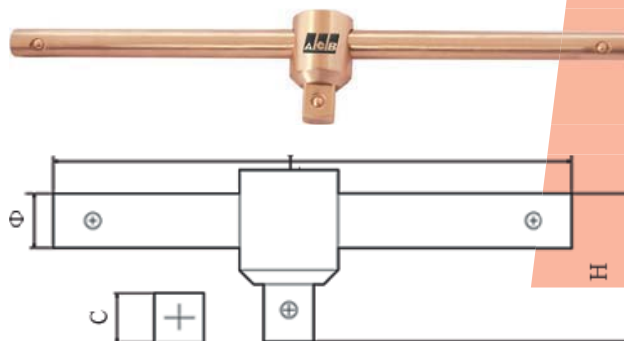

ADAPTATEUR

ADAPTATEUR

Adaptator / Adapter / Adaptador

F inch	M inch	H mm	Alliage / Alloy	
			Al-Br	Be-Cu
3/8"	1/4"	26	027602	014802
1/4"	3/8"	22	027604	014804
1/2"	3/8"	34	027605	014805
3/8"	1/2"	34	027614	014806
3/4"	1/2"	55	027612	014812
1/2"	3/4"	50	027608	014808
1"	3/4"	70	027620	014814
3/4"	1"	60	027616	014816
1-1/2"	1"	85	027618	014818
1	1-1/2"	85	027621	014821

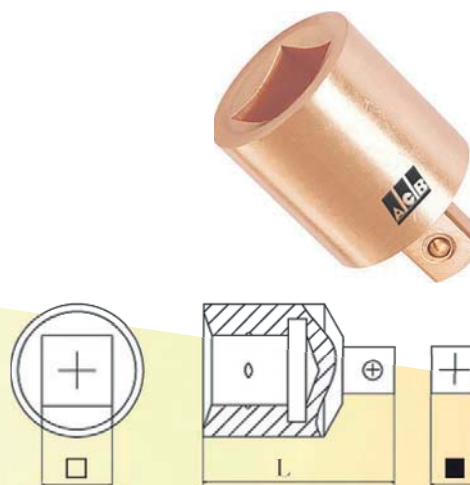

www.adf-safetytools.com



+33 (0) 3 27 78 01 02



+33 (0) 3 27 78 10 11



contact@adf-safetytools.com



ANTIDÉFLAGRANT
ANTIMAGNÉTIQUE
SAFETYTOOLS

www.adf-safetytools.com

POIGNÉE ARTICULÉE

Hinged handle / Gelenkgriff / Mango de Cabeza Deslizante

C inch	L mm	L ₁ mm	Alliage / Alloy	
			Al-Br	Be-Cu
1/4"	125	175	027300	014500
3/8"	190	175	027301	014501
1/2"	250	300	027302	014502
3/4"	286	260	027303	014503
1"	304	270	027304	014504

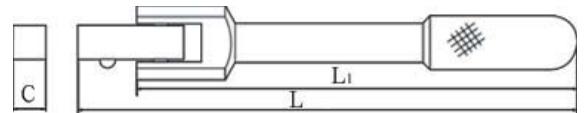

POIGNÉE COUDÉE

POIGNÉE COUDÉE

Offset handle / Winkelgriff / Mango acolado

C inch	L mm	Alliage / Alloy	
		Al-Br	Be-Cu
1/4"	200	027500	014700
3/8"	200	027501	014701
1/2"	230	027502	014702
3/4"	280	027503	014703
1"	300	027504	014704

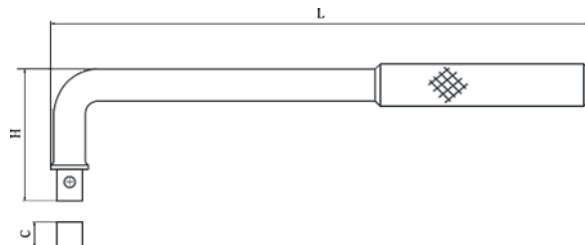

VILEBREQUIN

VILEBREQUIN

Speed handle / Winde / Manivela

C inch	L mm	H mm	Alliage / Alloy	
			Al-Br	Be-Cu
1/4"	125	28	026500	013700
3/8"	125	28	026501	013701
1/2"	245	43	026502	013702
3/4"	300	57	026503	013703
1"	550	64	026505	013705





CLÉ POLYGONALE A CLIQUET

Ratchet wrench / Schlüssel Ratsche / Llave trinquete

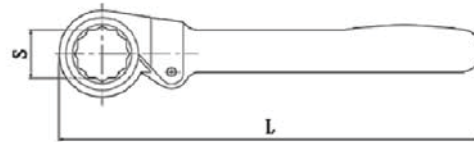

S mm	L mm	Alliage / Alloy	
		Al-Br	Be-Cu
9	150	082509	078109
11	150	082511	078111
13	155	082513	078113
14	155	082514	078114
17	200	082517	078117
19	200	082519	078119
22	220	082522	078122
24	220	082524	078124
27	245	082527	078127

S mm	L mm	Alliage / Alloy	
		Al-Br	Be-Cu
30	280	082530	078130
32	280	082532	078132
36	290	082536	078136
41	295	082541	078141
46	360	082546	078146
50	360	082550	078150
55	440	082555	078155
60	440	082560	078160

TOURNEVIS PORTE-DOUILLES

TOURNEVIS PORTE-DOUILLES

Spinner handle / Steckgriff / Atornillador

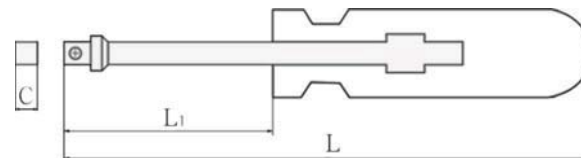

C inch	L mm	L ₁ mm	Alliage / Alloy	
			Al-Br	Be-Cu
1/4"	163	55	084002	079602
3/8"	185	65	084004	079604

CLÉ DYNAMOMÉTRIQUE

CLÉ DYNAMOMÉTRIQUE

Torque wrench / Drehmomentschlüssel / Dinamometricas de disparo



C inch	Torque Nm	L mm	Alliage / Alloy	
			Al-Br	Be-Cu
3/8"	100	310	029304	029303
1/2"	300	490	029302	029301
3/4"	500	560	029306	029305

ANTIDÉFLAGRANT
ANTIMAGNÉTIQUE
SAFETYTOOLS

www.adf-safetytools.com

CLÉ A FOURCHE PIED DE CORNEILLE

C inch	S inch	L mm	Alliage / Alloy	
			Al-Br	Be-Cu
3/8"	9/16"	35	084740	078340
3/8"	5/8"	37	084743	078343
3/8"	11/16"	38	084746	078346
3/8"	7/8"	43	084749	078349
3/8"	1-1/8"	50	084752	078352
3/8"	1-1/4"	53	084755	078355
3/8"	1-3/8"	56	084758	078358
3/8"	1-1/2"	59	084761	078361
3/8"	1-7/8"	72	084764	078364
3/8"	2"	75	084767	078367
3/8"	2-1/4"	81	084770	078370

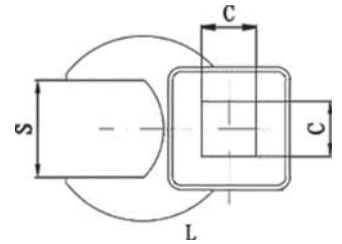

C inch	S inch	L mm	Alliage / Alloy	
			Al-Br	Be-Cu
1/2"	14"	40	084714	078314
1/2"	16"	43	084716	078316
1/2"	17"	43	084717	078317
1/2"	19"	49	084719	078319
1/2"	20"	49	084720	078320
1/2"	22"	52	084722	078322
1/2"	27"	59	084727	078327

CLÉ POLYGALE PIED DE CORNEILLE

CLÉ POLYGALE PIED DE CORNEILLE

Crow foot box end

C inch	S inch	L mm	Alliage / Alloy	
			Al-Br	Be-Cu
1/2"	7/8"	48	084775	078375
1/2"	1"	52	084780	078380
1/2"	1"-1/6"	54	084782	078382
1/2"	1"-1/8"	56	084784	078384
1/2"	1"-1/4"	62	084786	078386
1/2"	1"-5/16"	66	084788	078388
1/2"	1"-1/2"	72	084790	078390
1/2"	1"-5/8"	76	084792	078392
1/2"	2"	89	084794	078394

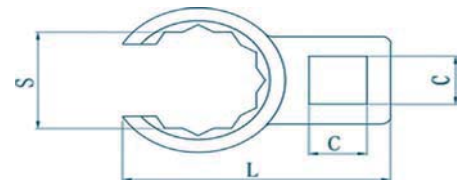

C inch	S inch	L mm	Alliage / Alloy	
			Al-Br	Be-Cu
3/8"	7/16"	29	084763	078363
3/8"	1/2"	31	084762	078362
3/8"	9/16"	33	084740	078340
3/8"	5/8"	38	084743	078343
3/8"	11/16"	41	084746	078346
3/8"	3/4"	43	084756	078356



COFFRET DOUILLES 1/2" 17 PCS

COFFRET DOUILLES 1/2" 17 PCS

1/2" Dr Socket Set 17 pcs

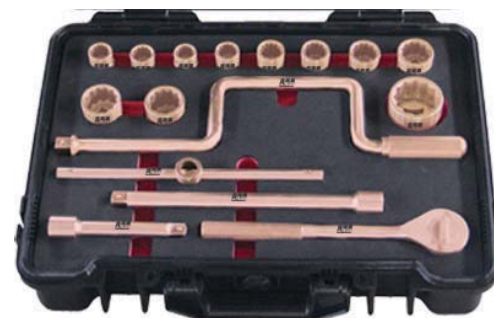

Composition	L mm	H mm	Ø mm	Alliage / Alloy	
				Al-Br	Be-Cu
Douilles 1/2"	40		10	026810	014010
	40		11	026811	014011
	40		12	026812	014012
	40		14	026814	014014
	40		17	026817	014017
	42		19	026819	014019
	43		22	026822	014022
	43		24	026824	014024
	46		27	026827	014027
	46		30	026830	014030
	46		32	026832	014032
Clé à cliquet 1/2"	245	43		026502	013702
Poignée coulissante 1/2"	250	39	13	026602	013802
Villebrequin 1/2"	390	96		027202	014402
Rallonge 1/2"	125			027113	014313
Rallonge 1/2"	250			027116	014316

ANTIDÉFLAGRANT
ANTIMAGNÉTIQUE
SAFETYTOOLS

www.adf-safetytools.com

COFFRET DOUILLES 1/2" 32 PCS

1/2" Dr Socket Set 32 pcs

Composition	L mm	H mm	Ø mm	Alliage / Alloy	
				Al-Br	Be-Cu
Douilles 1/2"	40		8	026808	014008
	40		9	026809	044009
	40		10	026810	014010
	40		11	026811	014011
	40		12	026812	014012
	40		13	026813	014013
	40		14	026814	014014
	40		15	026815	014015
	40		16	026816	014016
	40		17	026817	014017
	42		18	026818	014018
	42		19	026819	014019
	42		20	026820	014020
	43		21	026821	014021
	43		22	026822	014022
	43		23	026823	014023
	43		24	026824	014024
	43		26	026826	014026
	46		27	026827	014027
	46		28	026828	014028
46		30	026830	014030	
46		32	026832	014032	
Clé à cliquet 1/2"	245	43		026502	013702
Poignée coulissante 1/2"	250	39	13	026602	013802
Villebrequin 1/2"	390	96		027202	014402
Rallonge 1/2"	125			027113	014313
Rallonge 1/2"	250			027116	014316
Cardan universel 1/2"	80				
Cardan tournevis 1/2"	52	13			
Poignée coudée 1/2"	230			027502	014702
Malette de transport					





COFFRET DOUILLES 3/4" 21 PCS

3/4" Dr Socket Set 21 pcs

Composition	L mm	H mm	Ø mm	Alliage / Alloy	
				Al-Br	Be-Cu
Douilles 3/4"	55		21	026921	014121
	55		22	26922	014122
	55		23	026923	014123
	55		24	026924	014124
	55		26	026926	014126
	55		27	026927	014127
	55		28	026928	014128
	55		29	026829	014129
	60		30	026930	014130
	60		31	026931	014131
	60		32	026932	014132
	60		34	026934	014134
	60		36	026936	014136
	60		38	026938	014138
	65		41	026941	014141
	65		46	026946	014146
	70		50	026950	014150
Clé à cliquet 3/4"	320	57			
Poignée coulissante 3/4"	400	56	21		
Rallonge 3/4'	200			027120	014320
Malette de transport					



www.adf-safetytools.com



ANTIDÉFLAGRANT
ANTIMAGNÉTIQUE
SAFETYTOOLS

www.adf-safetytools.com

COFFRET DOUILLES 3/4" 14 PCS

3/4" Dr Socket Set 14 pcs

Composition	L mmm	H mm	Ø mm	Alliage / Alloy	
				Al-Br	Be-Cu
Douilles 3/4"	55		21	026921	014121
	55		24	026924	014124
	55		27	026927	014127
	60		30	026930	014130
	60		32	026932	014132
	60		34	026934	014134
	60		36	026936	014136
	60		38	026938	014138
	65		41	026941	014141
	65		46	026946	014146
	70		50	026950	014150
Clé à cliquet 3/4"	320	57			
Poignée coulissante 3/4"	400	56	21		
Rallonge 3/4"	200			027120	014320
Malette de transport					



COFFRET DOUILLES 1" 18 PCS

COFFRET DOUILLES 1" 18 PCS

1" Dr Socket Set 18 pcs

Composition	L mmm	H mm	Ø mm	Alliage / Alloy		
				Al-Br	Be-Cu	
Douilles 1"	60		30	039230	033630	
	60		31	039231	033631	
	60		32	039232	033632	
	60		34	039234	033634	
	60		36	039236	033636	
	65		38	039238	033638	
	70		41	039241	033641	
	75		46	039246	033646	
	75		50	039250	033650	
	75		55	039255	033655	
	85		60	039260	033660	
	85		65	039265	033665	
	90		70	039270	033670	
	90		75	039275	033675	
	90		80	039280	033680	
	Cardan rond 1"	100		21		
	Poignée coulissante 1"	400	62	21	013804	026604
Rallonge 1"	200			027125	014325	





CLÉS / CLÉS MIXTES

CLÉS A FRAPPER / CLÉS A MOLETTE

WRENCHES / ADJUSTABLE WRENCHES / STRIKING WRENCHES / ADJUSTABLES END WRENCHES
SCHLÜSSEL / RINGMAULSCHLÜSSEL / RINGSCHLAGSCHLÜSSEL / ROLLGABELSCHLÜSSEL
LLAVE / LLAVE COMBINADA / LLAVE GOLPE / LLAVE DE CABEZA AJUSTABLE



ANTIDÉFLAGRANT
ANTIMAGNÉTIQUE
SAFETYTOOLS

www.adf-safetytools.com



**ANTIDÉFLAGRANT
ANTIMAGNÉTIQUE
SAFETYTOOLS**

www.adf-safetytools.com

CLÉ À FOURCHE SIMPLE

Single open end wrench / Einfachmaulschlüssel, DIN 894 / Llave de Boca Sencilla

S mm	L mm	Alliage / Alloy	
		Al-Br	Be-Cu
6	83	019906	005106
7	87	019907	005107
8	95	019908	005108
9	97	019909	005109
10	110	019910	005110
11	110	019911	005111
14	140	019914	005114
17	160	019917	005117
19	170	019919	005119
20	180	019920	005120
21	185	019921	005121
22	195	019922	005122
23	205	019923	005123
24	220	019924	005124
27	240	019927	005127
30	260	019930	005130
32	280	019932	005132
34	290	019934	005134
36	310	019936	005136
39	325	019939	005139
41	345	019941	005141
42	360	019942	005142
46	375	019946	005146
48	395	019948	005148
50	410	019950	005150
55	450	019955	005155
60	490	019960	005160
65	530	019965	005165
70	570	019970	005170
75	610	019975	005175

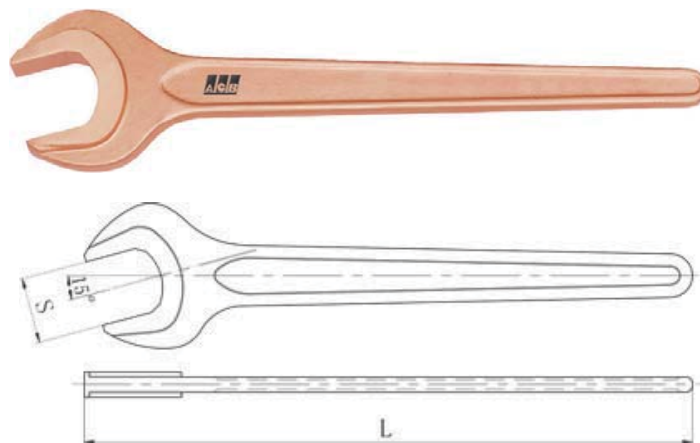



CLÉ POLYGOBALE SIMPLE

Single end box wrench / Einfachringschlüssel, DIN 3111 / Llave de Cajon Sencilla

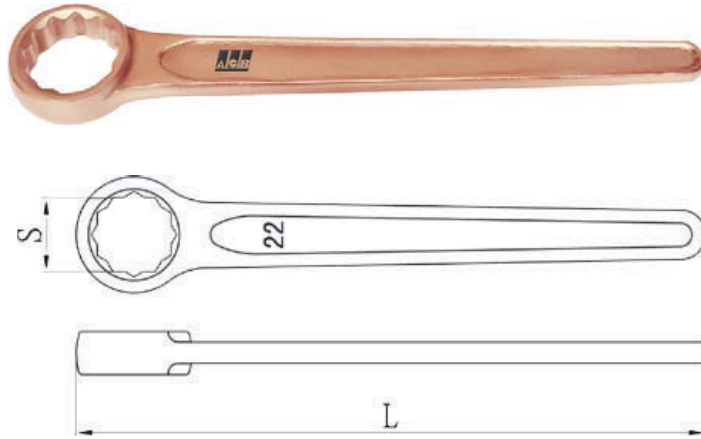

S mm	L mm	Alliage / Alloy	
		Al-Br	Be-Cu
8	110	019708	004908
10	120	019710	004910
12	130	019712	004912
14	140	019714	004914
16	145	019716	004916
17	155	019717	004917
18	160	019718	004918
19	170	019719	004919
20	176	019720	004920
21	183	019721	004921
22	190	019722	004922
24	215	019724	004924
27	230	019727	004927
30	255	019730	004930
32	265	019732	004932
34	280	019734	004934
36	295	019736	004936
41	330	019741	004941
45	326	019745	004945
46	365	019746	004946
48	340	019748	004948
50	400	019750	004950
55	445	019755	004955
56	374	019756	004956
60	474	019760	004960
65	510	019765	004965
70	555	019770	004970
75	590	019775	004975
80	470	019780	004980
85	490	019785	004985



ANTIDÉFLAGRANT
ANTIMAGNÉTIQUE
SAFETYTOOLS

www.adf-safetytools.com

CLÉ MIXTE

Combination wrench / Ringmaulschlüssel, DIN 3113 / Llave Combinada

S mm	L mm	Alliage / Alloy	
		Al-Br	Be-Cu
6	105	020206	005406
7	120	020207	005407
8	135	020208	005408
9	135	020209	005409
10	140	020210	005410
11	150	020211	005411
12	150	020212	005412
13	175	020213	005413
14	175	020214	005414
15	175	020215	005415
16	195	020216	005416
17	205	020217	005417
18	215	020218	005418
19	215	020219	020419
20	230	020220	020420
21	230	020221	005421
22	245	020222	005422
23	265	020223	005423
24	265	020224	005424
25	265	020225	005425
26	290	020226	005426
27	290	020227	005427
28	300	020228	005428
29	300	020229	005429
30	320	020230	005430
31	320	020231	005431
32	340	020232	005432
34	360	020234	005434
35	360	020235	005435
36	360	020236	005436

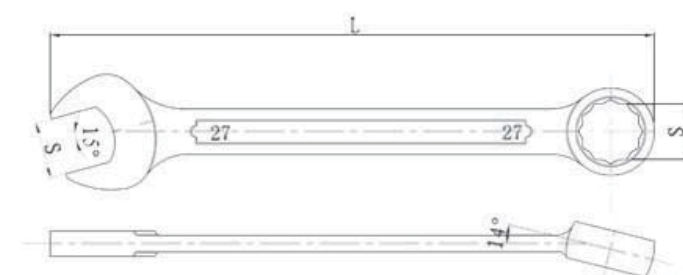

S mm	L mm	Alliage / Alloy	
		Al-Br	Be-Cu
40	430	020240	005440
41	430	020241	005441
46	480	020246	005446
50	520	020250	005450
55	560	020255	005455
60	595	020260	005460
65	595	020265	005465
70	630	020270	005470
75	630	020275	005475
80	630	020275	005475
85	630	020285	005485
90	630	020290	005490



CLÉ MIXTE US

Combination wrench / Ringmaulschlüssel DIN 3113 / Llave Combinada



S mm	L mm	Alliage / Alloy	
		Al-Br	Be-Cu
1/4"	115	035103	031303
5/16"	123	035106	031306
3/8"	128	035109	031309
7/16"	135	035112	031312
1/2"	140	035115	031315
9/16"	163	035118	031318
19/32"	173	035119	031319
5/8"	177	035121	031321
11/16"	195	035124	031324
3/4"	215	035127	031327
13/16"	230	035128	031328
7/8"	235	035130	031330

S mm	L mm	Alliage / Alloy	
		Al-Br	Be-Cu
15/16"	265	035131	031331
1"	265	035133	031333
1-1/16"	290	035136	031336
1-3/16"	320	035140	031340
1-1/8"	320	035139	031339
1-1/4"	340	035142	031342
1-5/16"	360	035145	031345
1-3/8"	360	035148	031348

CLÉ MIXTE COUDÉE

CLÉ MIXTE COUDÉE

Combination wrench

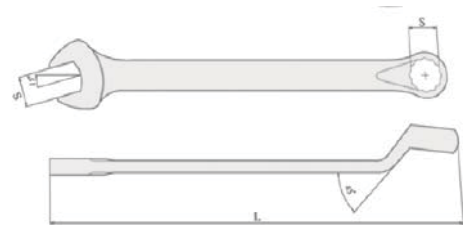

S mm	L inch	Alliage / Alloy	
		Al-Br	Be-Cu
17	240		
19	270		
21	290		
22	295		
24	320		
27	350		



ANTIDÉFLAGRANT
ANTIMAGNÉTIQUE
SAFETYTOOLS

www.adf-safetytools.com

CLÉ MIXTE - JEU DE 9 PIÈCES

Combination wrench, set of 9 pieces / Ringmaulschlüssel Sätze / Llave Combinada, luego

S mm	Alliage / Alloy	
	Al-Br	Be-Cu
8, 10, 12, 14, 17, 19, 22, 24, 27	037709	037609



CLÉ MIXTE - JEU DE 11 PIÈCES

CLÉ MIXTE - JEU DE 11 PIÈCES

Combination wrench, set of 11 pieces / Ringmaulschlüssel Sätze / Llave Combinada, luego

S mm	Alliage / Alloy	
	Al-Br	Be-Cu
8, 10, 12, 14, 17, 19, 22, 24, 27, 30,32	037709	037609



CLÉ MIXTE - JEU DE 13 PIÈCES

CLÉ MIXTE - JEU DE 13 PIÈCES

Combination wrench, set of 13 pieces / Ringmaulschlüssel Sätze / Llave Combinada, luego

S mm	Alliage / Alloy	
	Al-Br	Be-Cu
8, 10, 12, 13, 14, 16, 17, 19, 22, 24, 27, 30, 32	037713	037613





CLÉ À MOLETTE

Adjustable end wrench / Rollgabelschlüssel / Llave de Cabeza Ajustable

L mm	L inch	K mm	Alliage / Alloy	
			Al-Br	Be-Cu
100	4"	13	023607	009407
150	6"	18	023608	009408
200	8"	24	023609	009409
250	10"	30	023612	009412
300	12"	36	023616	009416
375	15"	46	023620	009420
450	18"	55	023623	009423
600	24"	65	023626	009426

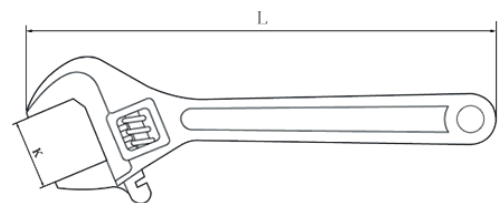

ANTIDÉFLAGRANT
ANTIMAGNÉTIQUE
SAFETYTOOLS

www.adf-safetytools.com

CLÉ À FOURCHE DOUBLE

Double open end wrench / Doppelmaulschlüssel, DIN 895 / Llave de Boca Doble

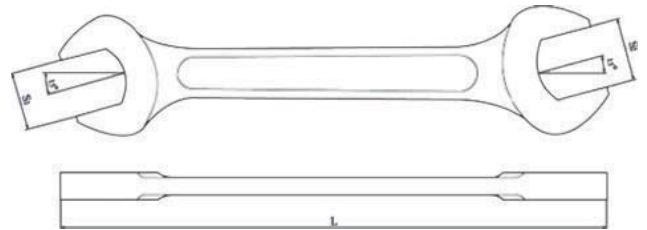

S ₁ *S ₂ mm	L mm	Alliage / Alloy	
		Al-Br	Be-Cu
5.5*7	90	019604	048804
6*7	92	019605	004805
6*8	94	019606	004806
7*8	97	019607	004807
7*9	96	019608	004808
8*9	98	019609	004809
8*10	100	019611	004811
9*10	105	019614	004814
9*11	110	019616	004816
10*11	115	019618	004818
10*12	120	019619	004819
11*13	125	019621	004821
12*13	128	019625	004825
12*14	130	019627	004827
13*14	140	019623	004823
13*15	140	019624	004824
14*15	143	019629	004829
14*17	150	019631	004831
16*17	157	019633	004833
16*18	160	019636	004836
17*19	170	019638	004838
17*22	175	019640	004840
18*20	180	019641	004841
18*19	179	019642	004842
19*22	185	019644	004844
19*24	190	019647	004847

S ₁ *S ₂ mm	L mm	Alliage / Alloy	
		Al-Br	Be-Cu
20*22	195	019649	004849
20*32	265	019673	004873
21*23	200	019651	004851
22*24	210	019653	004853
22*27	215	019655	004855
23*26	220	019656	004856
24*26	225	019658	004858
24*27	230	019660	004860
25*28	236	019664	004864
27*30	250	019669	004869
27*32	255	019671	004871
30*32	265	019673	004873
30*36	270	019675	004875
32*34	270	019676	004876
32*36	290	019677	004877
34*36	300	019679	004879
36*38	300	019680	004880
38*40	330	019683	004883
36*41	335	019682	004882
41*46	355	019684	004884
46*50	370	019686	004886
50*55	385	019688	004888
55*60	415	019693	004893
65*70	460	019697	004897
70*80	520	019699	004899



CLÉ À FOURCHE DOUBLE

Double open end wrench / Doppelmaulschlüssel, DIN 895 / Llave de Boca Doble

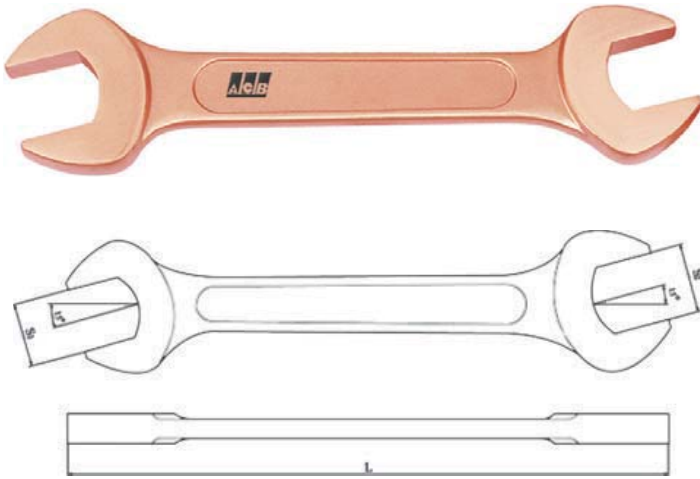

S ₁ *S ₂ mm	L mm	Alliage / Alloy	
		Al-Br	Be-Cu
7/32"*1/4"	90	034503	030703
1/4"*5/16"	90	034506	030706
5/16"*3/8"	100	034509	030709
3/8"*7/16"	110	034512	030712
3/8"*1/2"	115	034513	030713
7/16"*1/2"	120	034515	030715
1/2"*9/16"	130	034521	030721
9/16"*5/8"	150	034527	030727
5/8"*11/16"	160	034539	030739
5/8"*3/4"	165	034542	030742
11/16"*3/4"	170	034545	030745
3/4"*13/16"	180	034554	030754
3/4"*7/8"	185	034557	030757
13/16"*7/8"	190	034566	030766
7/8"*15/16"	210	034569	030769
15/16"*1"	220	034581	030781
1"*1-1/16"	230	034590	030790
1-1/16"*1-1/8"	235	034593	030793
1-1/8"*1-3/16"	245	034596	030796
1-1/4"*1-5/16"	260	034606	030806
1-5/16"*1-3/8"	295	034609	030809
1-3/8"*1-7/16"	320	034612	030812
1-7/16"*1-5/8"	335	034615	030815
1-1/2"*1-9/16"	350	034618	030818
1-5/8"*1-13/16"	355	034621	030821
1-13/16"*2"	370	034630	030830
2*2-3/16"	385	034633	030833
2"*2-3/8"	400	034636	030836
2-3/16"*2-3/8"	415	034639	030839
2-3/8"*2-9/16"	435	034642	030842

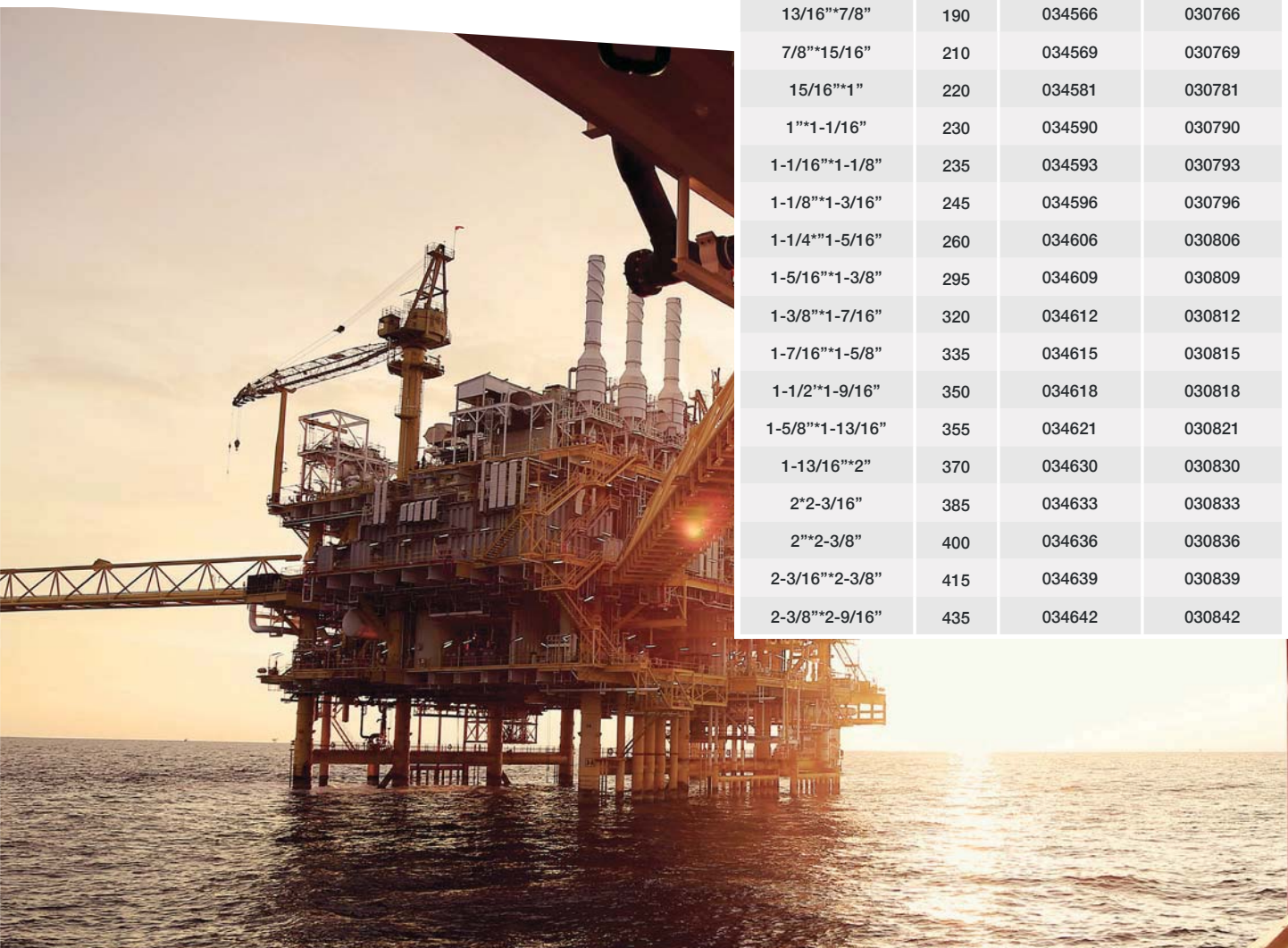



CLÉ À FOURCHE DOUBLE - JEU DE 9 PIÈCES

**ANTIDÉFLAGRANT
ANTIMAGNÉTIQUE
SAFETYTOOLS**

www.adf-safetytools.com

CLÉ À FOURCHE DOUBLE - JEU DE 9 PIÈCES

Double open end wrench, set of 9 pieces / Doppelmaulschlüssel, DIN 895, Sätze / Llave de Boca Doble, juego

S ₁ *S ₂ mm	Alliage / Alloy	
	Al-Br	Be-Cu
8*10, 10*12, 12*14, 14*17, 17*19, 19*22, 22*24, 24*27, 30*32	037909	037809



CLÉ À FOURCHE DOUBLE - JEU DE 11 PIÈCES

CLÉ À FOURCHE DOUBLE - JEU DE 11 PIÈCES

Double open end wrench, set of 11 pieces / Doppelmaulschlüssel, DIN 895, Sätze / Llave de Boca Doble, juego

S ₁ *S ₂ mm	Alliage / Alloy	
	Al-Br	Be-Cu
8*10, 9*11, 10*12, 12*14, 14*17, 17*19, 19*22, 22*24, 24*27, 27*30, 30*32	037911	037811



www.adf-safetytools.com



ANTIDÉFLAGRANT
ANTIMAGNÉTIQUE
SAFETYTOOLS



CLÉ À FOURCHE DOUBLE - JEU DE 13 PIÈCES

Double open end wrench, set of 13 pieces / Doppelmaulschlüssel, DIN 895, Sätze / Llave de Boca Doble, juego

S ₁ *S ₂ mm	Alliage / Alloy	
	Al-Br	Be-Cu
5.5*7, 6*7, 8*10, 9*11, 10*12, 12*14, 14*17, 17*19, 19*22, 22*24, 24*27, 27*30, 30*32	037913	037813



ANTIDÉFLAGRANT
ANTIMAGNÉTIQUE
SAFETYTOOLS

www.adf-safetytools.com

CLÉ POLYGONALE CONTRE-COUDÉE

Double end box wrench offset / Doppelringsschlüssel gekröpft, DIN 838 / Llave de Cajón Doble tipo acodado

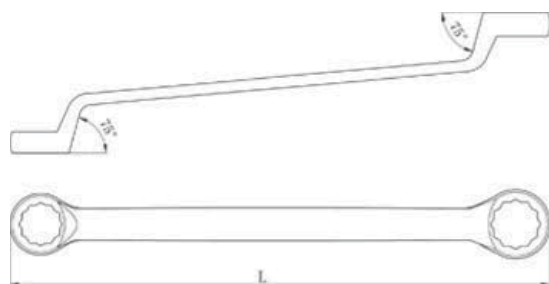

S ₁ *S ₂ mm	L mm	Alliage / Alloy	
		Al-Br	Be-Cu
5.5*7	115	019503	004703
6*7	115	019505	004705
7*9	130	019509	004709
8*9	128	019511	004711
8*10	130	019513	004713
9*11	140	019518	004718
10*11	140	019519	004719
10*12	140	019520	004720
12*13	160	019527	004727
12*14	160	019529	004729
14*15	200	019531	004731
14*17	200	019533	004733
16*17	220	019535	004735
16*18	220	019538	004738
17*19	250	019540	004740
17*22	250	019542	004742
18*19	250	019544	004744
19*22	280	019546	004746
19*24	310	019549	004749
20*22	292	019551	004751
21*23	285	019553	004753
21*26	320	019554	004754
22*24	310	019555	004755
24*26	333	019560	004760

S ₁ *S ₂ mm	L mm	Alliage / Alloy	
		Al-Br	Be-Cu
24*27	340	019562	004762
24*30	350	019564	004764
25*28	350	019566	004766
26*32	370	019567	004767
27*30	360	019571	004771
29*32	373	019574	004774
30*32	380	019575	004775
30*36	395	019577	004777
32*34	400	019578	004778
32*36	410	019579	004779
34*36	420	019580	004780
36*38	434	019581	004781
36*41	450	019583	004783
41*46	470	019585	004785
46*50	490	019587	004787
50*55	510	019589	004789
50*60	520	019591	004791
55*60	530	019593	004793
60*70	560	019595	004795





CLÉ POLYGONALE CONTRE-COUDÉE

Double end box wrench offset / Doppelringsschlüssel gekröpft, DIN 838 / Llave de Cajon Doble tipo acodado

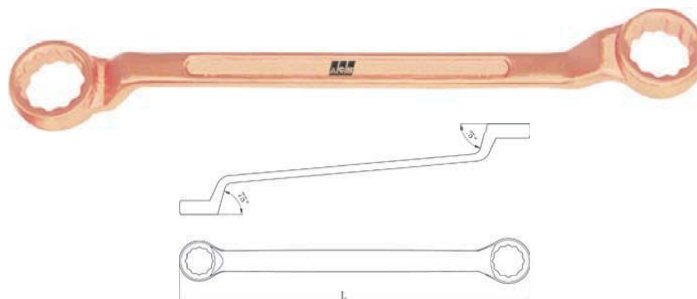

S ₁ *S ₂ mm	L mm	Alliage / Alloy	
		Al-Br	Be-Cu
1/4**5/16"	115	034406	030606
5/16**3/8"	125	034409	030609
3/8**7/16"	140	034412	030612
7/16**1/2"	155	034415	030615
1/2**9/16"	175	034418	030618
9/16**5/8"	215	034424	030624
5/8**11/16"	220	034426	030626
11/16**3/4"	245	034431	030631
3/4**13/16"	255	034434	030634
13/16**7/8"	275	034436	030636
7/8**15/16"	305	034440	030640
15/16**1"	310	034448	030648
1**1-1/16"	330	034453	030653
1-1/16**1-1/8"	330	034457	030657
1-1/8**1-3/16"	370	034462	030662
1-3/16**1-1/4"	370	034464	030664
1-1/4**1-5/16"	380	034466	030666
1-5/16**1-3/8"	410	034470	030670
1-3/8**1-7/16"	410	034471	030671
1-7/16**1-5/8"	450	034472	030672
1-1/2**1-9/16"	460	034473	030673
1-5/8**1-13/16"	470	034475	030675
1-13/16**2"	490	034478	030678
2**2-3/16"	510	034483	030683
2**2-3/8"	520	034484	030684
2-3/16**2-3/8"	530	034485	030685
2-3/8**2-3/4"	560	034489	030689



www.adf-safetytools.com



+33 (0) 3 27 78 01 02



+33 (0) 3 27 78 10 11



contact@adf-safetytools.com



CLÉ POLYGONALE CONTRE-COUDÉE - JEU DE 9 PIÈCES

ANTIDÉFLAGRANT
ANTIMAGNÉTIQUE
SAFETYTOOLS

www.adf-safetytools.com

CLÉ POLYGONALE CONTRE-COUDÉE - JEU DE 9 PIÈCES

Double end box wrench offset, set of 9 pieces / Doppelringschlüssel-Sätze, gekröpft / Llave de Cajon Doble tipo acodado, luego

S ₁ *S ₂ mm	Alliage / Alloy	
	Al-Br	Be-Cu
8*10, 10*12, 12*14, 14*17, 17*19, 19*22, 22*24, 24*27, 30*32	038709	038609



CLÉ POLYGONALE CONTRE-COUDÉE - JEU DE 11 PIÈCES

CLÉ POLYGONALE CONTRE-COUDÉE - JEU DE 11 PIÈCES

Double end box wrench offset, set of 11 pieces / Doppelringschlüssel-Sätze, gekröpft / Llave de Cajon Doble tipo acodado, luego

S ₁ *S ₂ mm	Alliage / Alloy	
	Al-Br	Be-Cu
8*10, 9*11, 10*12, 12*14, 14*17, 17*19, 19*22, 22*24, 24*27, 27*30, 30*32	038711	038611



CLÉ POLYGONALE CONTRE-COUDÉE - JEU DE 13 PIÈCES

CLÉ POLYGONALE CONTRE-COUDÉE - JEU DE 13 PIÈCES

Double end box wrench offset, set of 13 pieces / Doppelringschlüssel-Sätze, gekröpft / Llave de Cajon Doble tipo acodado, luego

S ₁ *S ₂ mm	Alliage / Alloy	
	Al-Br	Be-Cu
5.5*7, 6*7, 8*10, 9*11, 10*12, 12*14, 14*17, 17*19, 19*22, 22*24, 24*27, 27*30, 30*32	038713	038613





CLÉ POLYGONALE DOUBLE

Double end wrench / Doppelte schlüssel / Llave de anillo doble

S ₁ *S ₂ mm	L mm	Alliage / Alloy	
		Al-Br	Be-Cu
8*10	115	019410	004610
9*11	125	019413	004613
10*12	140	019417	004617
12*14	145	019428	004628
14*17	165	019434	004634
17*19	185	019443	004643
19*22	200	019452	004652
22*24	220	019464	004664
24*27	255	019473	004673
27*30	280	019483	004683
30*32	295	019486	004686
30*36	330	019488	004688
36*41	365	019493	004693

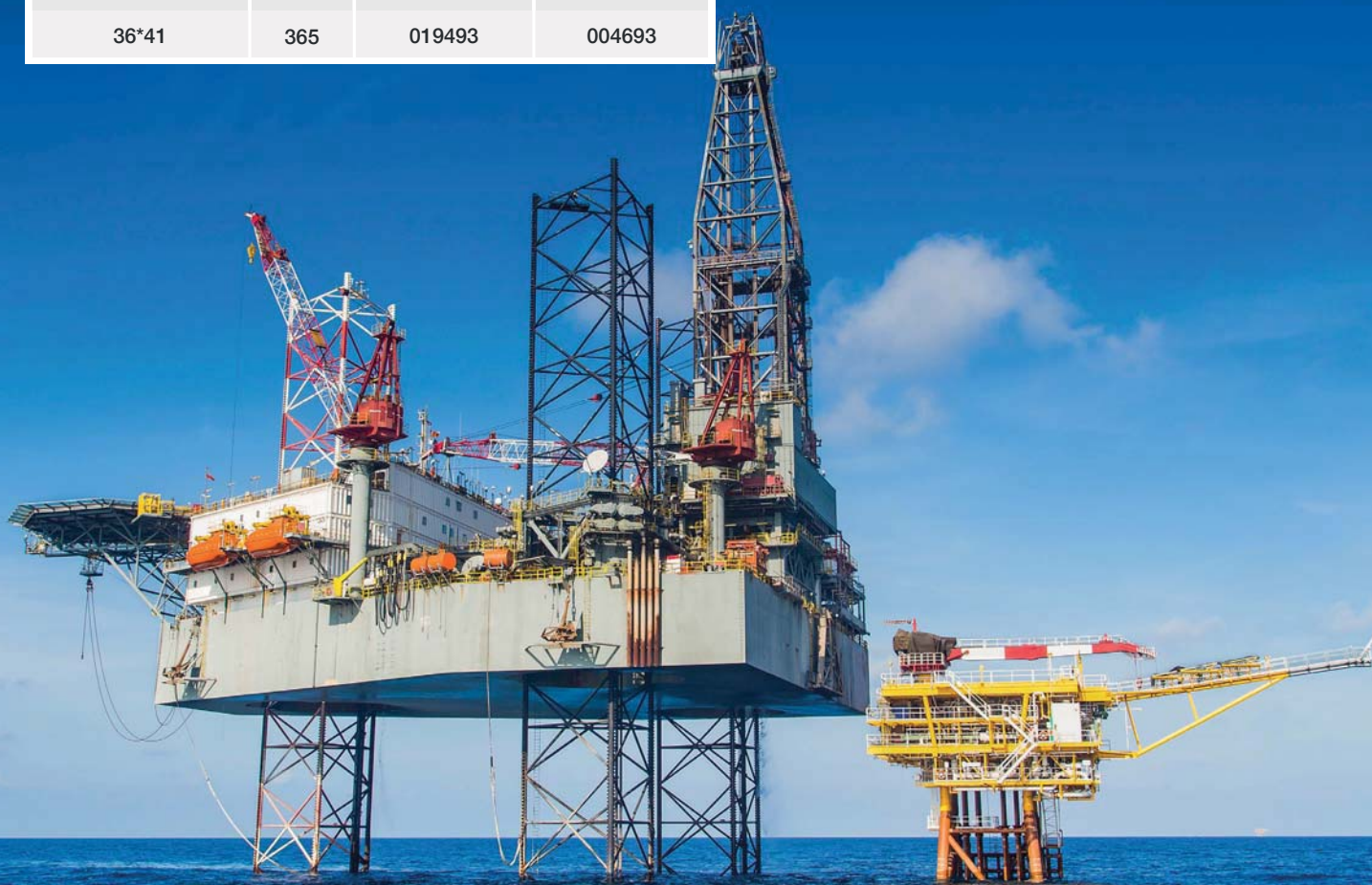
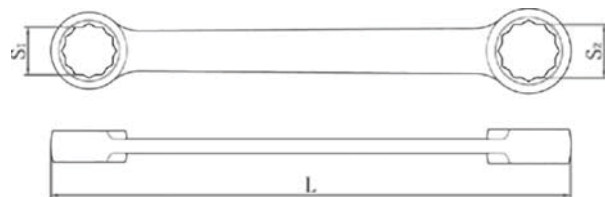

ANTIDÉFLAGRANT
ANTIMAGNÉTIQUE
SAFETYTOOLS

www.adf-safetytools.com

CLÉ MÂLE 6 PANS

Hex key / Allen key / Sechskant-Winkelschraubendreher (Inbus) DIN 911 / Llave Hexagonal Allen

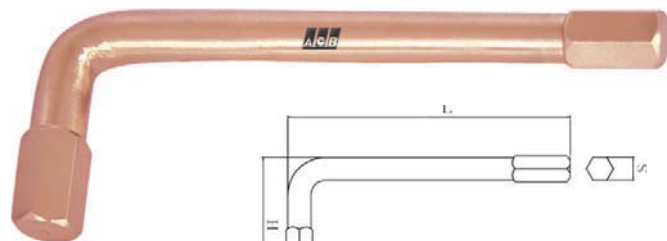

S mm	L mm	H mm	Alliage / Alloy	
			Al-Br	Be-Cu
1.5	38	13	021001	006201
2	38	13	021002	006202
2.5	38	13	021000	006200
3	59	25	021003	006203
4	65	30	021004	006204
5	79	32	021005	006205
6	85	37	021006	006206
7	88	43	021007	006207
8	92	44	021008	006208
9	97	44	021009	006209
10	110	45	021010	006210
11	119	48	021011	006211
12	130	52	021012	006212
13	140	54	021013	006213
14	150	58	021014	006214
15	156	60	021015	006215
16	162	63	021016	006216
17	168	65	021017	006217
18	173	69	021018	006218
19	177	72	021019	006219
21	184	74	021021	006221
22	186	77	021022	006222
23	192	82	021023	006223
24	200	84	021024	006224
25	206	90	021025	006225
26	213	93	021026	006226
27	222	95	021027	006227
28	240	105	021028	006228
29	240	105	021029	006229
30	240	105	021030	006230
32	266	116	021032	006232
36	294	128	021036	006236
41	320	140	021041	006241

S mm	L mm	H mm	Alliage / Alloy	
			Al-Br	Be-Cu
1/16"	38	13	035397	031597
5/64"	38	13	035398	031598
3/32"	38	13	035399	031599
7/64"	58	24	035302	031502
1/8"	58	24	035303	031503
9/64"	64	29	035306	031506
5/32"	65	30	035309	031509
3/16"	79	31	035312	031512
7/32"	85	37	035315	031515
1/4"	85	37	035318	031518
9/32"	88	43	035319	031519
5/16"	92	44	035321	031521
11/32"	97	44	035322	031522
3/8"	110	45	035324	031524
7/16"	119	48	035327	031527
1/2"	140	55	035330	031530
9/16"	150	58	035333	031533
5/8"	162	63	035336	031536
11/16"	168	65	035339	031539
3/4"	178	73	035342	031542
13/16"	184	77	035344	031544
7/8"	187	79	035345	031545
15/16"	192	82	035347	031547
1"	200	85	035348	031548
1-1/16"	213	93	035351	031551
1-1/8"	222	95	035354	031554
1-3/16"	240	105	035355	031555
1-1/4"	266	116	035357	031557
1-7/16"	294	128	035366	031566
1-5/8"	320	140	035372	031572



CLÉ MÂLE HEXAGONALE

Wrench, hex key / Sechskant-Winkelschraubendreher (Inbus) DIN 911 / Llave Hexagonal

S mm	L mm	H mm	Alliage / Alloy	
			Al-Br	Be-Cu
2	50	13	021065	006265
3	63	13	021067	006267
4	70	13	021070	006270
5	80	25	021073	006273
6	90	30	021076	006276
7	95	32	021080	006280
8	100	37	021083	006283
9	106	43	021085	006285
10	112	44	021088	006288
11	118	44	021090	006290
12	125	45	021092	006292



CLÉ MÂLE AVEC BOULE 6 PANS

CLÉ MÂLE AVEC BOULE 6 PANS

Wrench, hex key with ball / Inbusschlüssel mit ball / Llave hexagonal con bola

S mm	L mm	H mm	Alliage / Alloy	
			Al-Br	Be-Cu
2	50	16	084602	080202
3	63	20	084603	080203
4	70	25	084604	080204
5	80	28	084605	080205
6	90	32	084606	080206
7	95	34	084607	080207
8	100	36	084608	080208
9	106	38	084609	080209
10	112	40	084610	080210
11	118	42	084611	080211
12	125	45	084612	080212

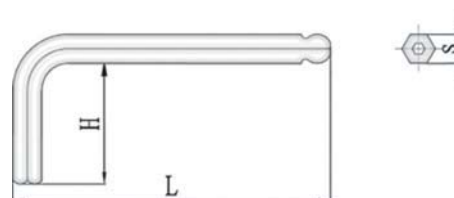

ANTIDÉFLAGRANT
ANTIMAGNÉTIQUE
SAFETYTOOLS

www.adf-safetytools.com

CLÉ MÂLE CARRÉ

Wrench, square key

S mm	L mm	H mm	Alliage / Alloy	
			Al-Br	Be-Cu
8	92	44		
9	97	44		
10	110	45		
11	119	48		
12	130	52		
13	140	54		
14	150	58		
15	156	60		
16	162	63		
17	168	65		
18	173	69		
19	177	72		

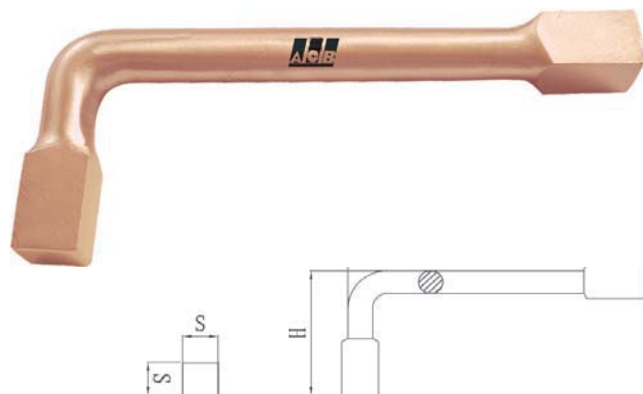

CLÉ MÂLE TORX

CLÉ MÂLE TORX

Torx key wrench

Size	L mm	H mm	Alliage / Alloy	
			Al-Br	Be-Cu
TX6	42	16		
TX7	48	16		
TX8	48	16		
TX9	48	16		
TX10	51	17		
TX15	54	18		
TX20	57	20		
TX25	60	20		
TX27	64	21		
TX30	70	24		
TX40	76	26		
TX45	83	29		
TX50	95	32		
TX55	108	35		
TX60	120	38		

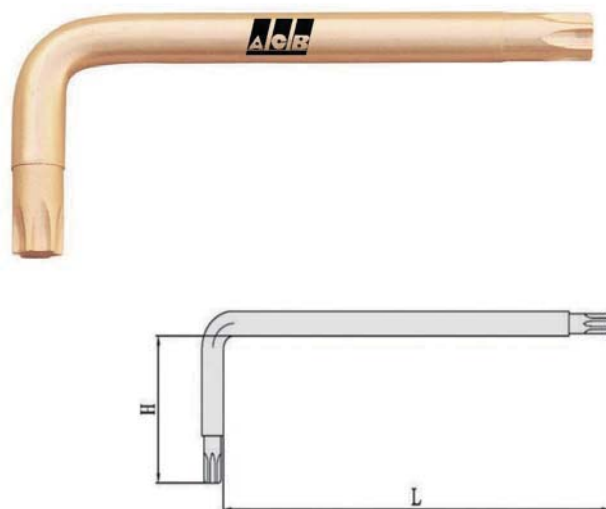



CLÉ À FOURCHE À BROCHE

Construction wrench with pin / Montageschlüssel mit Dorn / Llave de Construction con Perno

S mm	L mm	Alliage / Alloy	
		Al-Br	Be-Cu
19	240	020119	005319
22	260	020122	005322
24	280	020124	005324
27	300	020127	005327
30	320	020130	005330
32	340	020132	005332
36	360	020136	005336

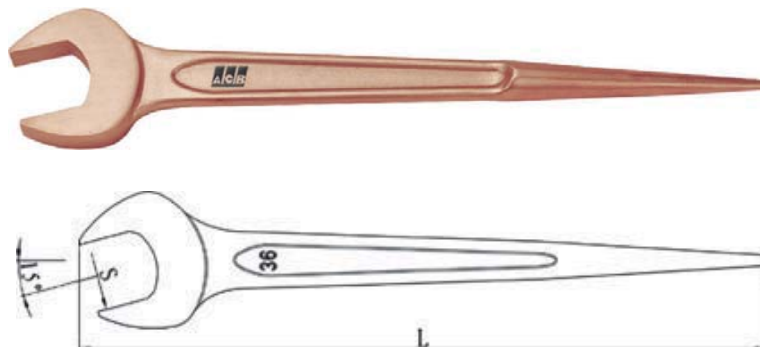

CLÉ À FOURCHE À BROCHE COUDÉE

CLÉ À FOURCHE À BROCHE COUDÉE

S mm	L mm	Alliage / Alloy	
		Al-Br	Be-Cu
17	82		
19	850		
22	850		
24	370		
27	370		
30	400		
32	400		
36	430		
41	470		
46	500		
50	530		
55	560		

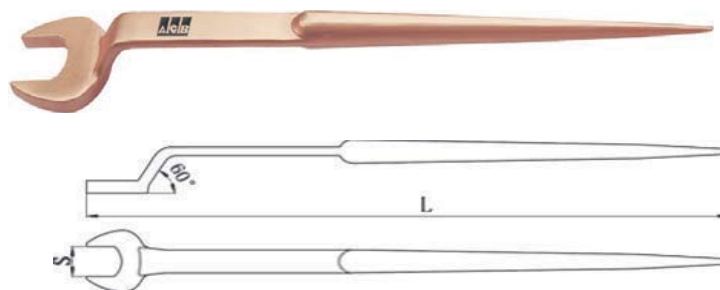

ANTIDÉFLAGRANT
ANTIMAGNÉTIQUE
SAFETYTOOLS

www.adf-safetytools.com

CLÉ À BROCHE POLYGONALE COUDÉE

Construction box wrench offset / Montageringschlüssel gekröpft / Llave de Construction, Acodada con Perno

S mm	L mm	Alliage / Alloy	
		Al-Br	Be-Cu
8	140	019808	005008
10	150	019810	005010
11	160	019811	005011
12	170	019812	005012
13	180	019813	005013
14	190	019814	005014
15	200	019815	005015
16	210	019816	005016
17	220	019817	005017
18	230	019818	005018
19	240	019819	005019
20	250	019820	005020
21	260	019821	005021
22	270	019822	005022
23	280	019823	005023
24	290	019824	005024
25	300	019825	005025
26	310	019826	005026
27	320	019827	005027
28	330	019828	005028
29	340	019829	005029

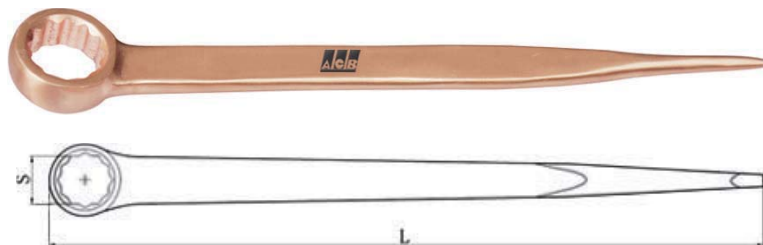

S mm	L mm	Alliage / Alloy	
		Al-Br	Be-Cu
30	350	019830	005030
32	370	019832	005032
34	380	019834	005034
35	385	019835	005035
36	390	019836	005036
38	400	019838	005038
41	410	019841	005041
46	420	019846	005046
50	430	019850	005050
55	440	019855	005055
60	460	019860	005060
65	480	019865	005065
70	500	019870	005070



CLÉ À VANNE

Key has valve / Schlüssel hat schieber / La llave tiene valvula

C mm	L mm	H mm	Alliage / Alloy	
			Al-Br	Be-Cu
6	110	9	083106	078706
8	120	10	083108	078708
9	140	11	083109	078709
10	140	12	083110	078710
11	160	13	083111	078711
12	190	14	083112	078712
13	200	15	083113	078713
14	250	16	083114	078714
16	250	18	083116	078716
17	300	19	083117	078717
19	350	20	083119	078719
22	400	22	083122	078722
24	500	24	083124	078724

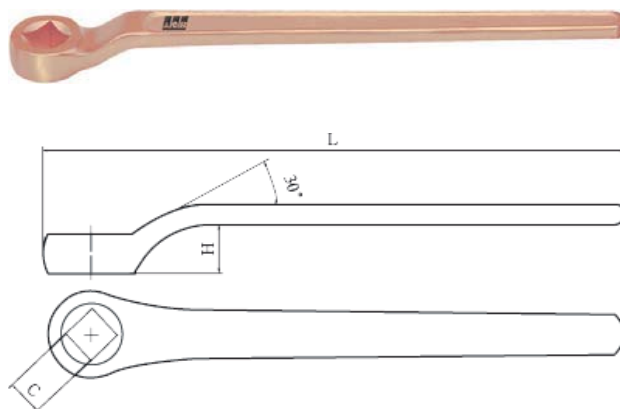

CLÉ BOUTEILLE OXYGÈNE

CLÉ BOUTEILLE OXYGÈNE

Oxygen Bottle Wrench / Sauerstoffschiessel / Llave de la botella de oxigeno

C inch	L mm	H mm	Alliage / Alloy	
			Al-Br	Be-Cu
3/8"	154	58	083303	078903

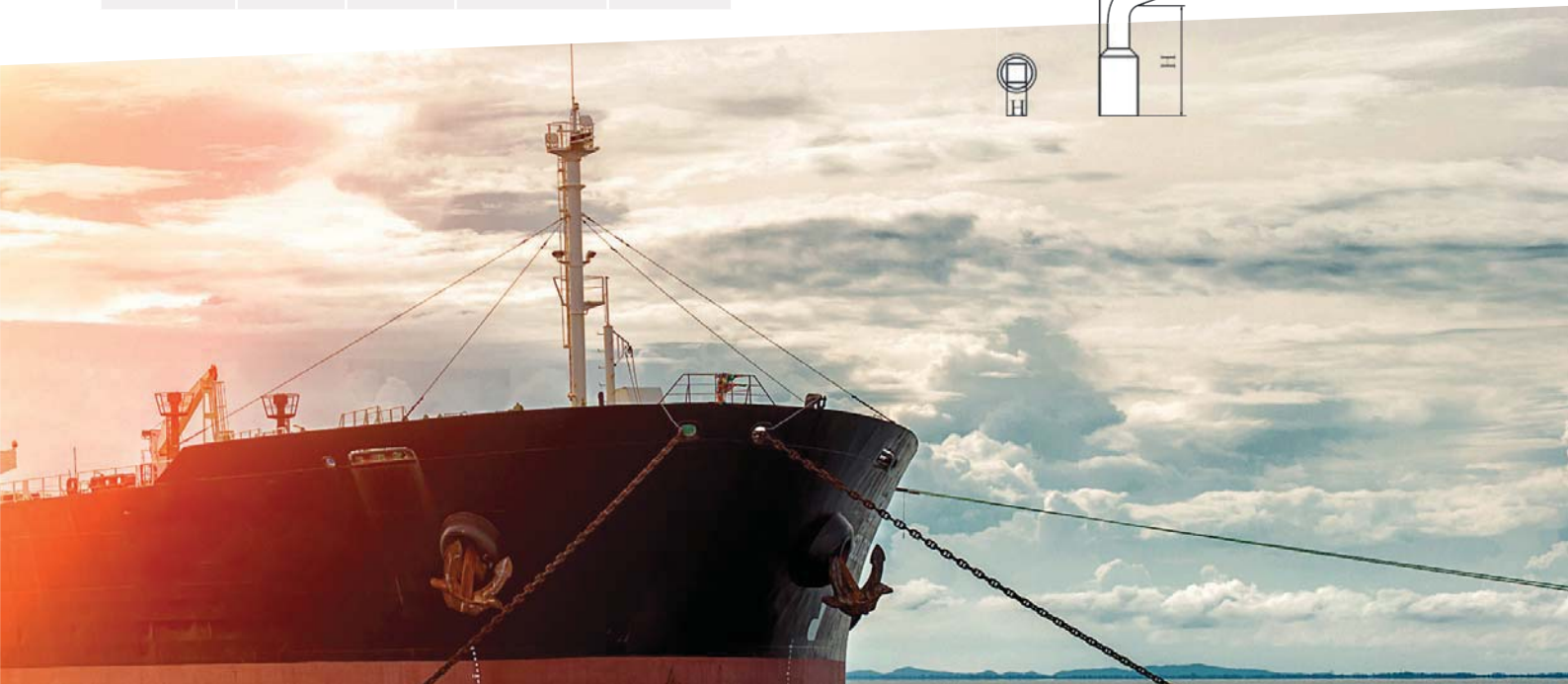
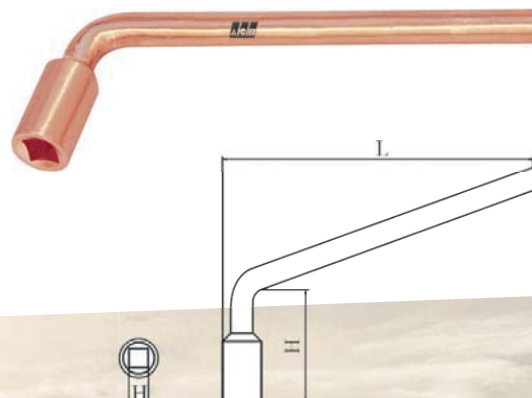



ANTIDÉFLAGRANT
ANTIMAGNÉTIQUE
SAFETYTOOLS

www.adf-safetytools.com

CLÉ SERRE-TUBE TYPE AMÉRICAIN

Adjustable pipe wrench / Verstellbarer Rohrschlüssel / Llave Adjustable para Tubos

L inch	L mm	K mm	K inch	Alliage / Alloy	
				Al-Br	Be-Cu
8"	200	25	1"	023702	009502
10"	250	30	1-1/4"	023708	009508
12"	300	40	1-1/2"	023709	009509
14"	350	50	2"	023710	009510
18"	450	60	2-1/2"	023711	009511
24"	600	75	3"	023717	009517
36"	900	85	5"	023720	009520
48"	1200	110	-	023723	009523

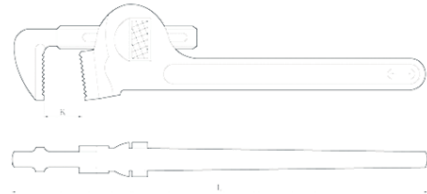

CLÉ À SANGLE

CLÉ À SANGLE

Wrench, Belt Pipe / Kettenrohrlicht-schlüssel / Llave, luz de codena de la pipa

L mm	L ₁ mm	S mm	Alliage / Alloy	
			Al-Br	Be-Cu
300	425	30	083202	078802

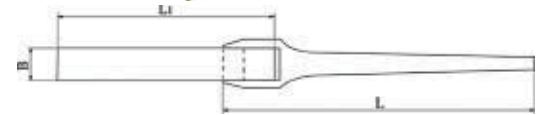

CLÉ SERRE-TUBE À CHAÎNE

CLÉ SERRE-TUBE À CHAÎNE

Chain pipe wrench / Kettenrohrzange / Llave Encadenadora de Tubos

L mm	D mm	K inch	Alliage / Alloy	
			Al-Br	Be-Cu
600	100	4"	024120	009920
1600	450	18"	0241--	009---

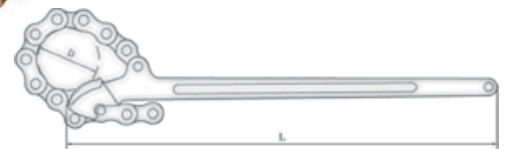

COUPE-TUBE

COUPE-TUBE

Pipe cutter / Rohrabschneider / Cortadora

D inch	D mm	Alliage / Alloy	
		Al-Br	Be-Cu
2"	50	-	015102
3"	75		

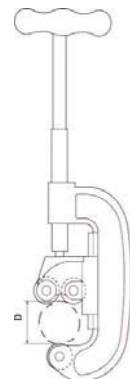



CLÉ ANGLAISE

Monkey (Railroad) wrench / Verstellbarer Schraubenschlüssel / Llave Inglesa (Ferrocarril)

K max inch	L mm	Alliage / Alloy	
		Al-Br	Be-Cu
48	254	023825	009625
58	305	023830	009630
65	350	023835	009635
70	380	023838	009638

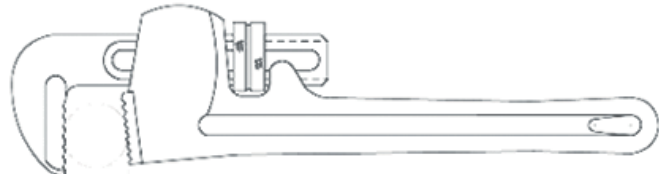

CLÉ SERRE-TUBE - TYPE SUÉDOIS

CLÉ SERRE-TUBE - TYPE SUÉDOIS

Pliers, Swedish / Eckrohrzange / Pinza Sueca

K max inch	L mm	Alliage / Alloy	
		Al-Br	Be-Cu
430	38	024003	077503
530	50	024005	077505

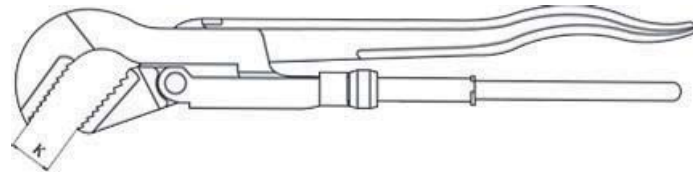

CLÉ SERRE-TUBE - TYPE SUÉDOIS 45°

CLÉ SERRE-TUBE - TYPE SUÉDOIS 45°

Adjustable pipe wrench Swedish type 45°

L mm	K mm	Alliage / Alloy	
		Al-Br	Be-Cu
430	38		
530	50		

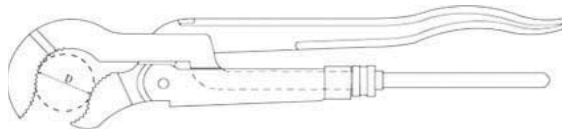

SERRE-TUBE À CHAÎNE

SERRE-TUBE À CHAÎNE

Chaine pipe wrench / Kettenrohrzange / Llave Encadenadora de Tubos

L mm	K mm	D inch	Alliage / Alloy	
			Al-Br	Be-Cu
600	50	2"	024105	009905
600	100	4"	024107	009907
600	150	6"	024109	009909
900	200	8"	024110	009910
900	300	12"	024111	009911

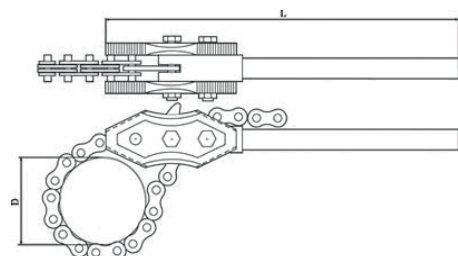

ANTIDÉFLAGRANT
ANTIMAGNÉTIQUE
SAFETYTOOLS

www.adf-safetytools.com

CLÉ À FRAPPER À FOURCHE

Striking open end wrench / Maulschlüssel, DIN 133 / Llave de Boca de Golpe

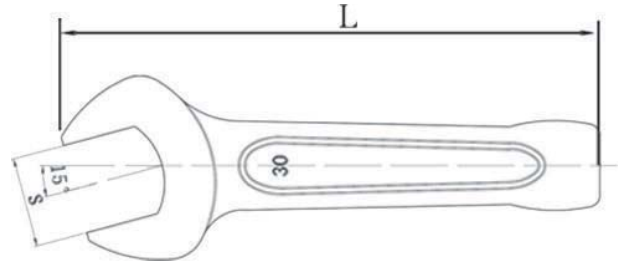

S mm	L mm	Alliage / Alloy	
		Al-Br	Be-Cu
10	110	018410	003610
13	110	018413	003613
16	110	018416	003616
17	125	018417	003617
18	135	018418	003618
19	125	018419	003619
22	135	018422	003622
24	150	018424	003624
26	172	018426	003626
27	175	018427	003627
28	178	018428	003628
29	182	018429	003629
30	190	018430	003630
32	190	018432	003632
35	200	018435	003635
36	200	018436	003636
37	210	018437	003637
38	216	018438	003638
41	230	018441	003641
42	228	018442	003642
45	237	018445	003645
46	250	018446	003646
50	275	018450	003650
52	261	018452	003652
55	305	018455	003655

S mm	L mm	Alliage / Alloy	
		Al-Br	Be-Cu
56	273	018456	003656
60	315	018460	003660
63	297	018463	003663
65	335	018465	003665
70	370	018470	003670
75	375	018475	003675
76	400	018476	003676
80	400	018480	003680
85	400	018485	003685
90	445	018490	003690
95	445	018495	003695
100	485	018500	003700
105	485	018505	003705
110	515	018510	003710
115	513	018515	003715
120	530	018520	003720
125	530	018525	003725
130	560	018530	003730
135	560	018535	003735
140	630	018540	003740
145	630	018545	003745
150	630	018550	003750
155	645	018555	003755
160	645	018560	003760



CLÉ À FRAPPER À FOURCHE

Striking open end wrench / Maulschlüssel, DIN 133 / Llave de Boca de Golpe

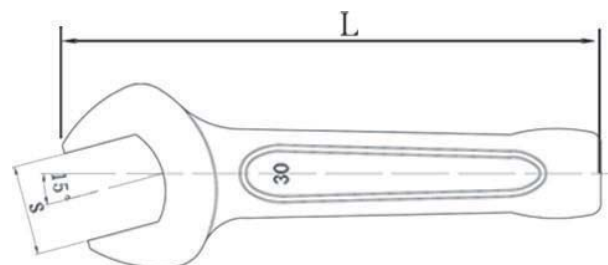

S mm	L mm	Alliage / Alloy	
		Al-Br	Be-Cu
11/16"	125	033806	030006
3/4"	125	033809	030009
7/8"	135	033812	030012
15/16"	150	033813	030013
1"	165	033815	030015
1-1/16"	165	033818	030018
1-1/8"	180	033819	030019
1-3/16"	180	033820	030020
1-1/4"	190	033821	030021
1-7/16"	200	033823	030023
1-3/8"	210	033822	030022
1-13/32"	210	033824	030024
1-1/2"	230	033826	030026
1-5/8"	230	033827	030027
1-3/4"	240	033829	030029
1-13/16"	240	033830	030030
1-7/8"	250	033825	030025
2"	255	033833	030033
2-1/16"	255	033834	030034
2-3/16"	272	033836	030036
2-13/64"	272	033837	030037

S mm	L mm	Alliage / Alloy	
		Al-Br	Be-Cu
2-5/16"	290	033838	030038
2-3/8"	290	033839	030039
2-1/8"	305	033835	030035
2-1/2"	307	033840	030040
2-9/16"	307	033842	030042
2-5/8"	307	033843	030043
2-1/4"	315	033841	030041
2-3/4"	325	033844	030044
2-15/16"	343	033845	030045
3"	343	033848	030048
3-1/16"	360	033849	030049
3-1/8"	360	033851	030051
3-3/8"	380	033853	030053
3-9/16"	400	033860	030060
3-3/4"	400	033862	030062
3-15/16"	430	033865	030065
4"	485	033866	030066
4-1/8"	498	033867	030067
4-1/4"	500	033872	030072
4-5/8"	525	033876	030076



ANTIDÉFLAGRANT
ANTIMAGNÉTIQUE
SAFETYTOOLS

www.adf-safetytools.com

CLÉ À FRAPPER POLYGONALE 12 PANS

Striking box wrench 12 points / Ringschlagschlüssel, 12-Kant, DIN 744 / Llave de Cajón de Golpe, 12 Puntos

S mm	L mm	Alliage / Alloy	
		Al-Br	Be-Cu
10	120	018810	004010
13	120	018813	004013
16	120	018816	004016
17	145	018817	004017
19	145	018819	004019
20	145	018820	004020
21	145	018821	004021
22	155	018822	004022
23	140	018823	004023
24	165	018824	004024
25	140	018825	004025
26	140	018826	004026
27	175	018827	004027
28	150	018828	004028
29	165	018829	004029
30	185	018830	004030
31	185	018831	004031
32	185	018832	004032
33	180	018833	004033
34	200	018834	004034
35	200	018835	004035
36	205	018836	004036
37	205	018837	004037
38	210	018838	004038
40	210	018840	004040
41	225	018841	004041
42	230	018842	004042
45	230	018845	004045
46	235	018846	004046
47	235	018847	004047
50	250	018850	004050
52	250	018852	004052
54	265	018854	004054
55	265	018855	004055
56	265	018856	004056
57	265	018857	004057
58	274	018858	004058
60	274	018860	004060

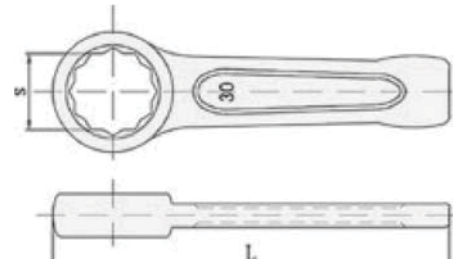

S mm	L mm	Alliage / Alloy	
		Al-Br	Be-Cu
63	288	018863	004063
65	288	018865	004065
67	310	018867	004067
70	320	018870	004070
71	310	018871	004071
75	326	018875	004075
77	325	018877	004077
80	350	018880	004080
82	340	018882	004082
85	355	018885	004085
88	380	018888	004088
90	380	018890	004090
94	390	018894	004094
95	390	018895	004095
100	410	018900	004100
105	420	018905	004105
110	445	018910	004110
120	480	018915	004115
128	510	018928	004128
130	510	018930	004130
140	520	018940	004140
145	565	018945	004145
150	565	018950	004150
155	565	018955	004155
160	635	018960	004160



CLÉ À FRAPPER POLYGONALE 12 PANS

Striking box wrench 12 points / Ringschlagschlüssel, 12-Kant, DIN 744 / Llave de Cajon de Golpe, 12 Puntos

S mm	L mm	Alliage / Alloy	
		Al-Br	Be-Cu
11/16"	145	034003	030203
3/4"	145	034005	030205
7/8"	155	034007	030207
1"	175	034009	030209
1-1/16"	175	034011	030211
1-1/8"	185	034012	030212
1-3/16"	185	034013	030213
1-1/4"	185	034015	030215
1-3/8"	200	034016	030216
1-13/32"	208	034018	030218
1-1/2"	215	034019	030219
1-5/8"	225	034021	030221
1-3/4"	235	034022	030222
1-13/16"	235	034024	030224
2"	250	034027	030227
2-1/16"	258	034028	030228
2-3/16"	264	034029	030229
2-13/64"	266	034030	030230
2-5/16"	273	034033	030233
2-3/8"	275	034036	030236
2-1/2"	282	034039	030239
2-9/16"	286	034042	030242
2-5/8"	291	034045	030245
2-3/4"	298	034048	030248
2-15/16"	311	034051	030251
3"	314	034054	030254
3-1/16"	319	034057	030257
3-1/8"	325	034060	030260
3-3/8"	339	034063	030263
3-9/16"	355	034066	030266
3-3/4"	370	034069	030269
3-15/16"	387	034072	030272
4-1/8"	405	034075	030275

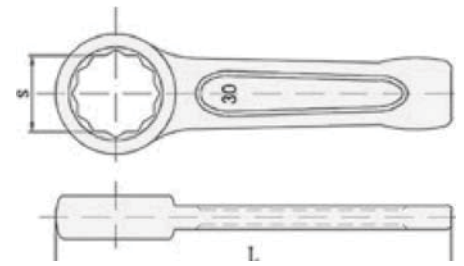

ANTIDÉFLAGRANT
ANTIMAGNÉTIQUE
SAFETYTOOLS

www.adf-safetytools.com

CLÉ À FRAPPER POLYGONALE GROS TRAVAUX

Striking box wrench 12 points - Heavy Duty / Ringschlagschlüssel, 12-Kant, DIN 744- Hocaleistung / Llave de Cajón de Golpe, 12 Puntos-Resistente

S mm	L mm	Alliage / Alloy	
		Al-Br	Be-Cu
24	180	019024	004224
27	180	019027	004227
30	180	019030	004230
32	180	019032	004232
34	190	019034	004234
36	225	019036	004236
38	225	019038	004238
40	250	019040	004240
41	200	019041	004241
42	250	019042	004242
46	265	019046	004246
48	265	019048	004248
50	280	019050	004250
52	280	019052	004252
55	300	019055	004255
56	300	019056	004256
58	300	019058	004258
60	310	019060	004260
62	310	019062	004262
64	320	019064	004264
65	320	019065	004265
66	320	019066	004266
68	330	019068	004268
70	350	019070	004270
75	360	019075	004275
80	370	019080	004280
85	390	019085	004285
90	400	019090	004290
95	415	019095	004295
98	430	019098	004298
100	430	019100	004300
105	430	019105	004305
110	460	019110	004310
115	480	019115	004315
120	480	019120	004320

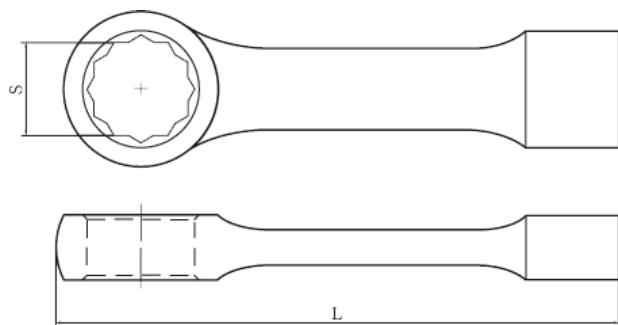



CLÉ À FRAPPER POLYGONALE GROS TRAVAUX

Striking box wrench 12 points - Heavy Duty / Ringschlagschlüssel, 12-Kant, DIN 744- Hocaleistungs / Llave de Cajon de Golpe, 12 Puntos-Resistente

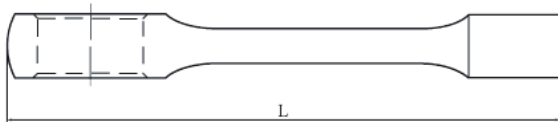
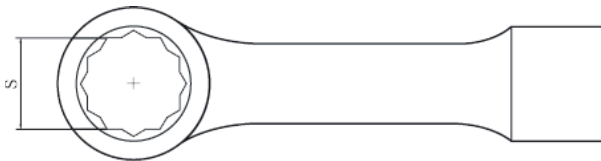

S inch	L mm	Alliage / Alloy	
		Al-Br	Be-Cu
15/16"	205	034103	030303
1"	205	034104	030304
1-1/16"	205	034106	030306
1-1/4"	220	034109	030309
1-5/16"	220	034110	030310
1-7/16"	225	034112	030312
1-1/2"	225	034113	030313
1-5/8"	250	034115	030315
1-11/16"	250	034116	030316
1-13/16"	265	034118	030318
1-7/8"	265	034119	030319
2"	280	034121	030321
2-1/16"	280	034122	030322
2-3/16"	280	034124	030324
2-1/4"	300	034125	030325
2-3/8"	310	034127	030327
2-7/16"	310	034128	030328
2-9/16"	320	034130	030330
2-5/8"	320	034131	030331
2-3/4"	350	034133	030333
2-13/16"	360	034134	030334
2-15/16"	360	034136	030336
3-1/8"	370	034139	030339
3-3/8"	390	034142	030342
3-1/2"	400	034145	030345
3-3/4"	415	034148	030348
3-7/8"	430	034151	030351
4-1/4"	460	034154	030354
4-1/2"	480	034157	030357
4-5/8"	480	034160	030360

www.adf-safetytools.com



ANTIDÉFLAGRANT
ANTIMAGNÉTIQUE
SAFETYTOOLS

www.adf-safetytools.com

CLÉ POLYGONALE A FRAPPER, ANGLE 45°

S mm	L mm	Alliage / Alloy	
		Al-Br	Be-Cu
24	160	080324	084424
27	175	080327	084427
30	190	080330	084430
32	190	080332	084432
36	210	080336	084436
41	225	080341	084441
46	240	080346	084446
50	255	080350	084450
55	270	080355	084455
60	285	080360	084460
65	300	080365	084465
70	320	080370	084470

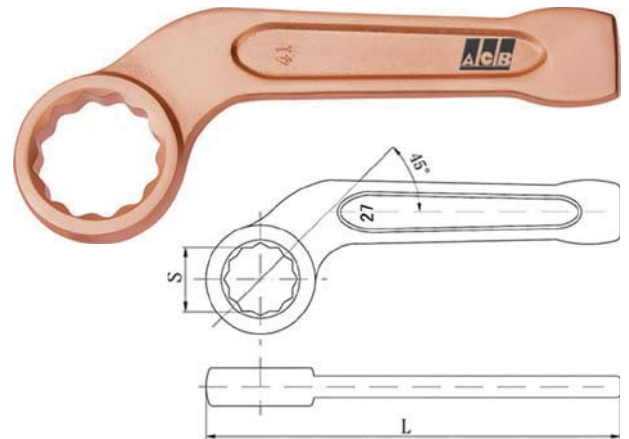

CLÉ À FRAPPER POLYGONALE COUDÉE 60°

CLÉ À FRAPPER POLYGONALE CONTRE COUDÉE 60°

Hex ring spanner offset - flogging / Ringschlagschlüssel, gekröpft / Llave de Cajon de Golpe, 12 puntos

S mm	L mm	Alliage / Alloy	
		Al-Br	Be-Cu
24	160	083824	083924
27	180	083827	083927
30	200	083830	083930
32	200	083832	083932
36	220	083836	083936
41	245	083841	083941
46	250	083846	083946
50	270	083850	083950
55	295	083855	083955
60	317	083860	083960
65	330	083865	083965
70	350	083870	083970
75	370	083875	083975
80	380	083880	083980

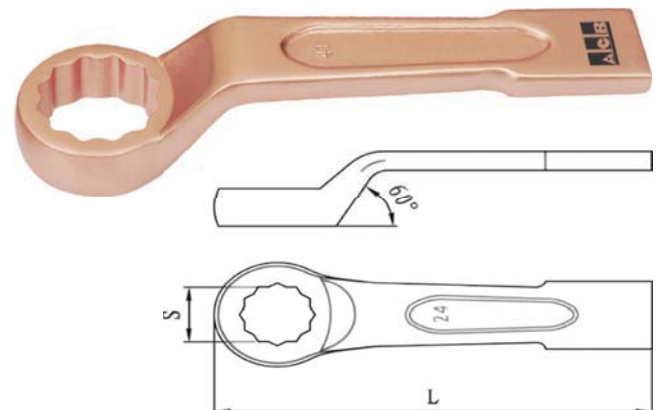



CLÉ À FRAPPER POLYGONALE COUDÉE

Double Hex ring spanner offset - flogging / Ringschlagschlüssel, gekröpft / Llave de Cajon de Golpe, 12 puntos

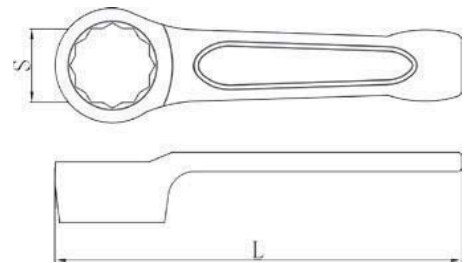

S mm	L mm	Alliage / Alloy	
		Al-Br	Be-Cu
27	175	019227	004427
30	185	019230	004430
32	185	019232	004432
34	210	019234	004434
36	210	019236	004436
41	227	019241	004441
46	245	019246	004446
50	257	019250	004450
55	267	019255	004455
60	278	019260	004440
65	298	019265	004465
70	320	019270	004470
75	326	019275	004475
80	435	019280	004480
85	440	019285	004485
90	440	019290	004490
95	440	019295	004495
100	440	019300	004500
105	440	019305	004505
110	440	019310	004510
115	440	019315	004515
120	440	019320	004520

S inch	L mm	Alliage / Alloy	
		Al-Br	Be-Cu
1"	240	034202	030402
1-1/16"	245	034205	030405
1-1/4"	270	034208	030408
1-5/16"	270	034210	030410
1-7/16"	280	034211	030411
1-1/2"	290	034213	030413
1-5/8"	310	034214	030414
1-11/16"	310	034216	030416
1-13/16"	320	034217	030417
1-7/8"	320	034219	030419
2"	320	034220	030420
2-1/16"	320	034222	030422
2-3/16"	320	034223	030423
2-1/4"	320	035225	030425
2-3/8"	355	034226	030426
2-7/16"	355	034227	030427
2-9/16"	380	034229	030429
2-5/8"	380	034231	030431
2-3/4"	400	034232	030432
2-13/16"	400	034234	030434
2-15/16"	420	034235	030435
3-1/8"	435	034238	030438
3-1/2"	440	034244	030444
3-7/8"	440	034250	030450



ANTIDÉFLAGRANT
ANTIMAGNÉTIQUE
SAFETYTOOLS

www.adf-safetytools.com

CLÉ À PIPE 6 PANS

Socket wrench L-type, 6 points / Steckschlüssel, gewinkelt, 6-kant / Llave para Cubo, Tipo-L, 6 puntos

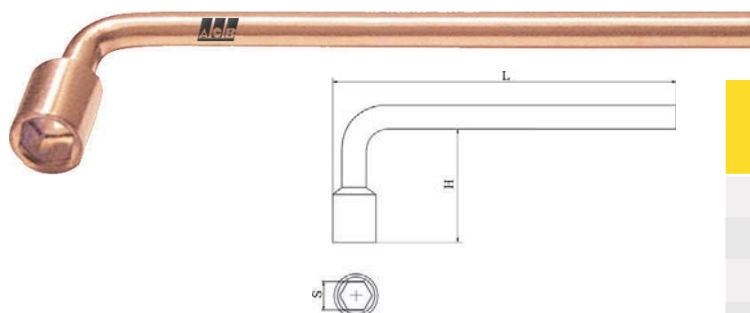

S mm	L mm	Alliage / Alloy	
		Al-Br	Be-Cu
41	350	025441	011241
42	350	025442	011242
46	360	025446	011246
47	360	025447	011247
50	370	025450	011250
52	370	025452	011252
54	380	025454	011254
55	380	025455	011255
56	380	025456	011256
58	390	025458	011258
60	390	025460	011260
63	400	025463	011263
65	410	025465	011265
67	420	025467	011267
70	420	025470	011270
71	420	025471	011271
75	430	025475	011275
77	430	025477	011277
80	440	025480	011280
82	440	025482	011282

S mm	L mm	Alliage / Alloy	
		Al-Br	Be-Cu
6	120	025406	011206
8	144	025408	011208
9	155	025409	011209
10	168	025410	011210
11	192	025411	011211
12	216	025412	011212
13	240	025413	011213
14	245	025414	011214
15	250	025415	011215
16	255	025416	011216
17	260	025417	011217
18	265	025418	011218
19	270	025419	011219
20	272	025420	011220
21	275	025421	0011221
22	278	025422	011222
23	282	025423	011223
24	286	025424	011224
25	285	025425	011225
26	294	025426	011226
27	294	025427	011227
28	294	025428	011228
29	302	025429	011229
30	302	025430	011230
32	310	025432	011232
33	310	025433	011233
34	310	025434	011234
35	310	025435	011235
36	330	025436	011236
37	330	025437	011237
38	330	025438	011238



CLÉ À PIPE 6 PANS

Socket wrench L-type, 6 points / Steckschlüssel, gewinkelt, 6-kant / Llave para Cubo, Tipo-L, 6 puntos

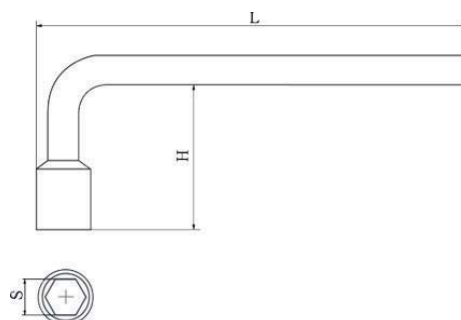

S inch	L mm	Alliage / Alloy	
		Al-Br	Be-Cu
5/16"	144	036103	032303
3/8"	155	036105	032305
13/32"	168	036107	032307
7/16"	192	036109	032309
1/2"	216	036110	032310
9/16"	245	036112	032312
19/32"	250	036113	032313
5/8"	255	036114	032314
11/16"	260	036115	032315
3/4"	270	036118	032318
25/32"	272	036119	032319
13/16"	275	036120	032320
7/8"	278	036121	032321
15/16"	282	036124	032234
31/32"	286	036125	032235
1"	286	036126	032326
1-1/16"	294	036127	032327
1-1/8"	294	036130	032330
1-3/16"	302	036131	032331
1-1/4"	302	036133	032333
1-5/16"	310	036134	032334
1-3/8"	310	036135	032335
1-7/16"	310	036136	032336

Dim mm	L mm	Alliage / Alloy	
		Al-Br	Be-Cu
1-1/2"	330	036137	032337
1-9/16"	330	036138	032338
1-5/8"	330	036139	032339
1-11/16"	330	036140	032340
1-3/4"	350	036141	032341
1-13/16"	350	036142	032342
1-7/8"	360	036143	032343
2"	360	036145	032345
2-1/16"	370	036146	032346
2-1/8"	30	036147	032347
2-3/16"	380	036148	032348
2-1/4"	380	036149	032349
2-5/16"	380	036150	032350
2-3/8"	390	036151	032351
2-7/16"	390	036152	032352
2-1/2"	400	036153	032353
2-9/16"	410	036154	032354
2-5/8"	410	036155	032355
2-3/4"	420	036156	032356
2-13/16"	430	036158	032358
3"	430	036159	032359
3-1/8"	440	036160	032360
3-1/4"	440	036161	032361



ANTIDÉFLAGRANT
ANTIMAGNÉTIQUE
SAFETYTOOLS

www.adf-safetytools.com

CLÉ À PIPE DÉBOUCHÉE TYPE L

Wrench, Socket L-type

S mm	L mm	H mm	Alliage / Alloy	
			Al-Br	Be-Cu
6	102	18		
7	106	18		
8	114	22		
9	122	22		
10	129	25		
11	136	25		
12	144	28		
13	152	30		
14	160	32		
15	169	3		
16	178	35		
17	187	40		
18	195	40		
19	204	45		
21	221	50		
22	230	50		
24	250	55		
27	280	65		
30	310	70		
32	330	75		
34	350	75		
36	370	80		

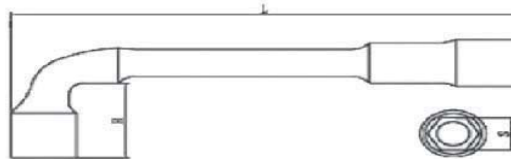



CLÉ POLYGONALE A TRACTION

Ring wrench to traction / Schraubenschlüssel, Traktion / Llave a la tracción

S mm	L mm	Alliage / Alloy	
		Al-Br	Be-Cu
24	180	021524	006724
27	190	021527	006727
30	200	021530	006730
32	235	021532	006732
33	235	021533	006733
34	245	021534	006734
35	245	021535	006735
36	245	021536	006736
37	245	021537	006737
41	265	021541	006742
42	265	021542	006742
46	280	021546	006746
50	290	021550	006750
55	300	021555	006755
60	345	021560	006760
65	355	021565	006765
70	365	021570	006770
75	375	021575	006775
80	385	021580	006780

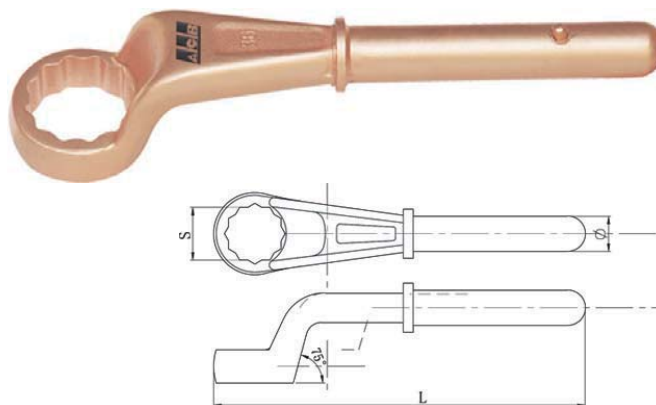

TUBE LEVIER POUR CLEF POLYGONALE A TRACTION

TUBE LEVIER POUR CLEF POLYGONALE A TRACTION

Extension for ring wrench / Hebelrohr / Tubo de palanca por llave a la tracción

Ø mm	mm	L mm	Alliage / Alloy	
			Al-Br	Be-Cu
19	24-30	460	021619	006819
22	32-41	610	021622	006822
25	46-55	760	021625	006825
30	60-80	860	021630	006830

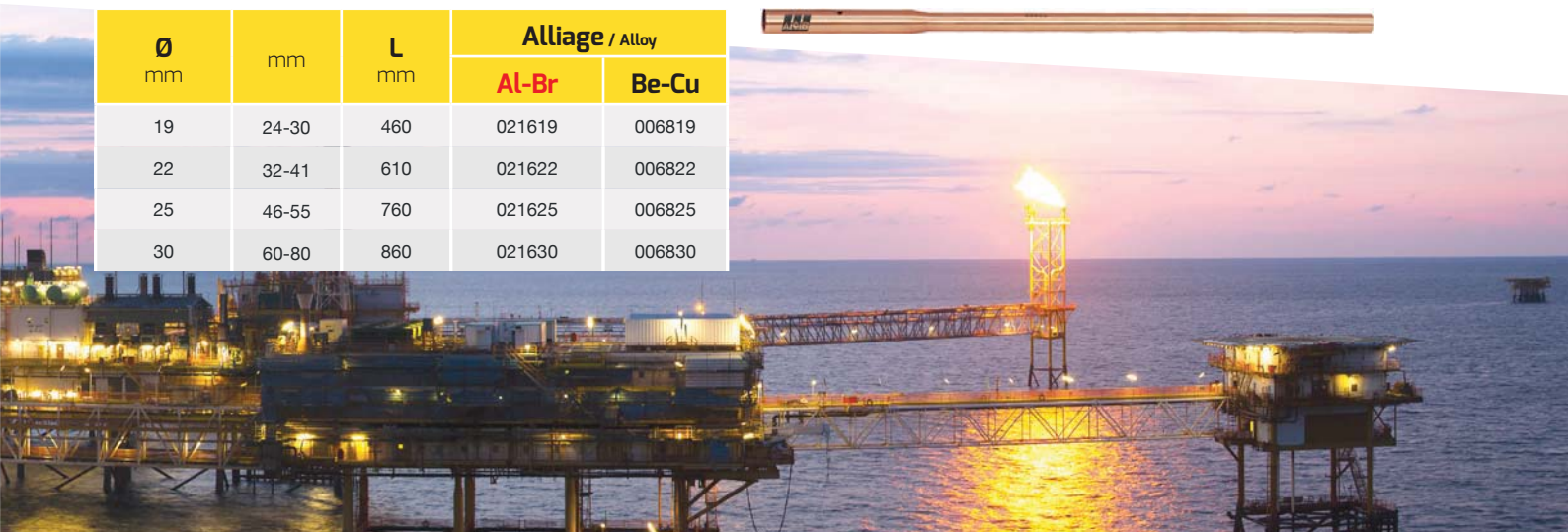

ANTIDÉFLAGRANT
ANTIMAGNÉTIQUE
SAFETYTOOLS

www.adf-safetytools.com

CLÉ À VALVE

Valve wheel hook / Ventilhaken / Gancho Girador de Valvulas

S mm	L mm	H mm	Alliage / Alloy	
			Al-Br	Be-Cu
30	200	44	020402	005602
35	250	49	020404	005604
40	300	50	020406	005606
45	350	61	020408	005608
48	375	62	020410	005610
50	400	67	020412	005612
55	450	73	020414	005614
60	500	79	020416	005616
65	550	80	020418	005618
70	650	85	020420	005620
75	650	91	020422	005622
80	700	97	020424	005624
85	750	103	020426	005626
90	800	103	020428	005628
93	850	107	020430	005630
96	900	110	020432	005632
100	1000	114	020434	005634
103	1200	120	020436	005636

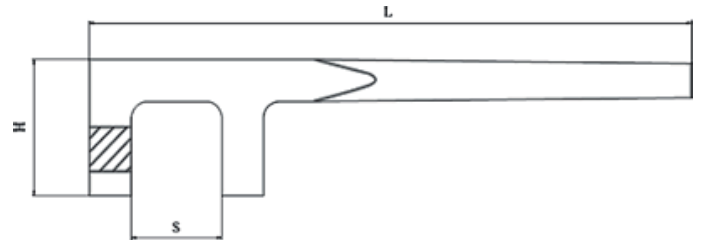

www.adf-safetytools.com



CLÉ À VALVE

CLÉ À VALVE

Valve wheel hook / Ventilhaken / Gancho Girador de Valvulas

S mm	L mm	H mm	Alliage / Alloy	
			Al-Br	Be-Cu
22	200	50	020472	005672
28	250	53	020474	005674
34	300	56	020476	005676
39	350	60	020478	005678
44	400	64	020480	005680
48	450	69	020482	005682
53	500	74	020486	005686
63	600	85	020488	005688

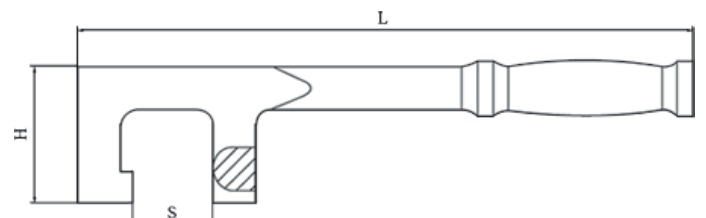



CLÉ À VALVE

Valve wheel hook / Ventilhaken / Gancho Girador de Valvulas

S mm	L mm	H mm	Alliage / Alloy	
			Al-Br	Be-Cu
30	200	44	020440	005640
32	300	50	020442	005642
35	250	47	020444	005644
40	300	50	020446	005646
45	350	58	020448	005648
48	375	62	020450	005650
50	400	67	020452	005652
55	450	73	020454	005654
60	500	79	020456	005646
65	550	82	020458	005658
70	600	85	020460	005660
75	650	88	020462	005662
80	700	91	020464	005664
85	750	97	020466	005666
90	800	103	020468	005668

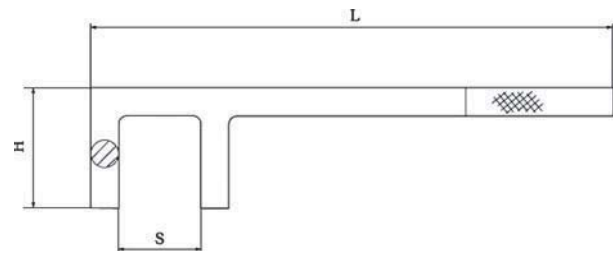

CLÉ À VALVE

CLÉ À VALVE

Valve wheel hook / Ventilhaken / Gancho Girador de Valvulas

S mm	L mm	H mm	Alliage / Alloy	
			Al-Br	Be-Cu
30	15	250	020725	005925
40	20	300	020730	005930
50	25	400	020740	005940
60	30	550	020755	005955
130	65	750	020775	005975

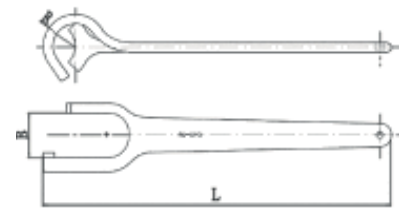

CLÉ POUR FÛT

CLÉ POUR FÛT

Bung wrench / Fassschlüssel / Llave taponadora

L mm	S ₁ mm	S ₂ mm	Alliage / Alloy	
			Al-Br	Be-Cu
300	38	52	017102	002203

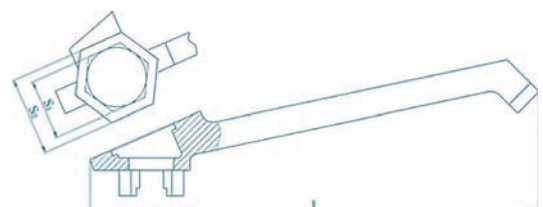

ANTIDÉFLAGRANT
ANTIMAGNÉTIQUE
SAFETYTOOLS

www.adf-safetytools.com

CLÉ À VOLANT

Wrench, C / Lenkradschlüssel / Clave a volante

L mm	S mm	Alliage / Alloy	
		Al-Br	Be-Cu
450	40	083504	079104

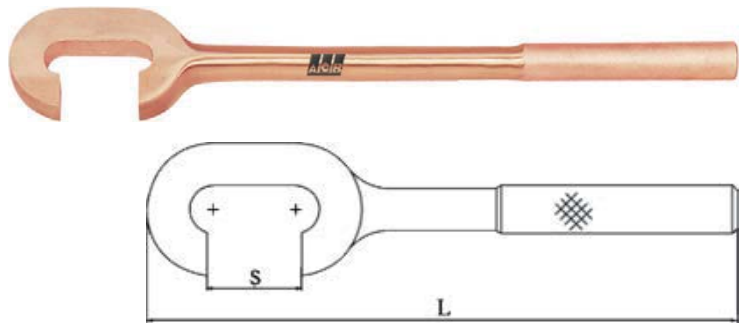

CLÉ À VOLANT

CLÉ À VOLANT

Wrench, C / Lenkradschlüssel / Clave a volante

L mm	Ø mm	H mm	Alliage / Alloy	
			Al-Br	Be-Cu
600	32	32	083508	079108

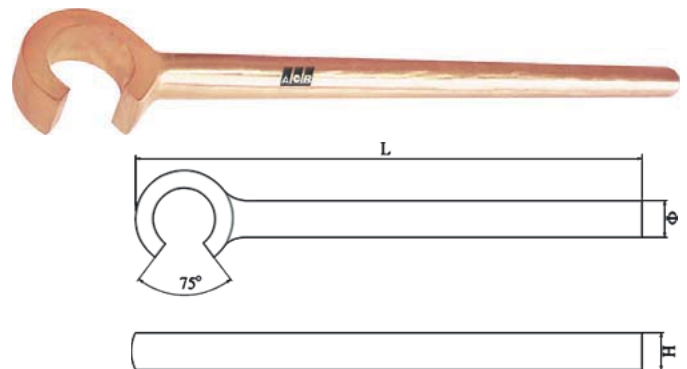

CLÉ À VOLANT

CLÉ À VOLANT

Wrench, C / Lenkradschlüssel / Clave a volante

L mm	S ₁ mm	S ₂ mm	Alliage / Alloy	
			Al-Br	Be-Cu
200	20	15	083506	079106
250	17.5	25.5	083507	079107
450	25.5	34	083504	079104

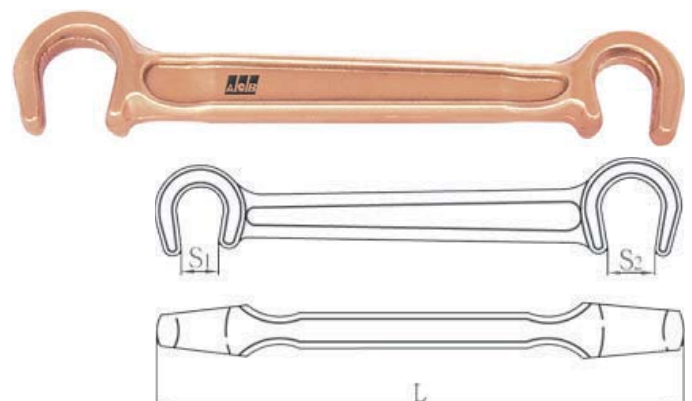



CLÉ POUR FÛT

Multi-head bung wrench / Universalfasschlüssel / Llave taponadora universal

L mm	H mm	Alliage / Alloy	
		Al-Br	Be-Cu
300	70	017000	002100

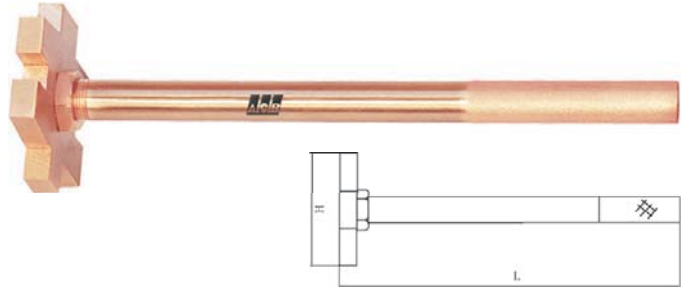

CLÉ POUR FÛT

CLÉ POUR FÛT

Multi-head bung wrench / Universalfasschlüssel / Llave taponadora universal

L mm	H ₁ mm	H ₂ mm	Alliage / Alloy	
			Al-Br	Be-Cu
350	70	95	017001	002101



CLÉ UNIVERSELLE POUR DÉBONDER LES FÛTS

CLÉ UNIVERSELLE POUR DÉBONDER LES FÛTS

Multi-head bung wrench / Universalfasschlüssel / Llave taponadora universal

L mm	H ₁ mm	H ₂ mm	Alliage / Alloy	
			Al-Br	Be-Cu
385	93	61	017101	002201

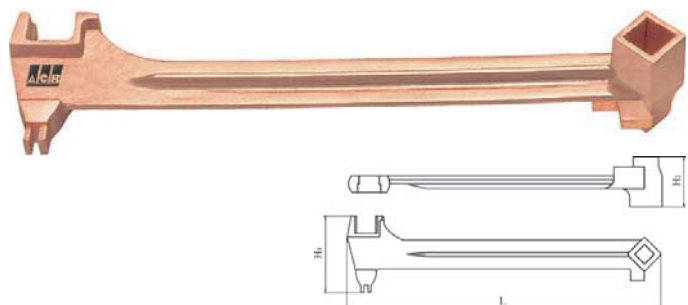

ANTIDÉFLAGRANT
ANTIMAGNÉTIQUE
SAFETYTOOLS

www.adf-safetytools.com

CLÉ À ERGOT

Hook spanner / Hakenschlüssel / Llave de Gancho

D mm	L mm	Alliage / Alloy	
		Al-Br	Be-Cu
12-14	100	020802	006002
16-20	100	020804	006004
25-28	130	020806	006006
30-32	140	020808	006008
34-36	170	020810	006010
40-42	176	020811	006011
45-50	209	020812	006012
50-80		020813	006013
52-55	212	020814	006014
58-62	144	020816	006016
68-75	250	020818	006018
80-90	284	020820	006020
95-100	288	020822	006022
100-110	330	020824	006024
110-115	337	020826	006026
115-170		020827	006027
120-130	343	020828	006028
135-145	388	020830	006030

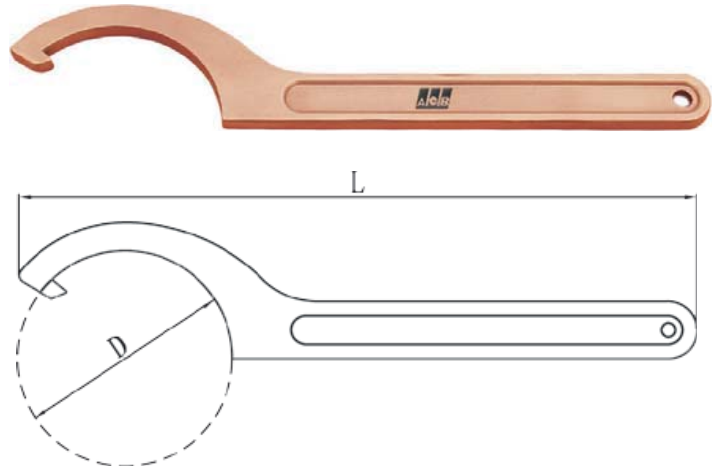

CLÉ À ERGOT ARTICULÉE

CLÉ À ERGOT ARTICULÉE

Adjustable hook / Gelenkhakenschlüssel / Llave de Gancho Ajustable

D mm	L mm	Alliage / Alloy	
		Al-Br	Be-Cu
19-50	162	020901	006101
32-75	205	020902	006102
38-100		020904	006104
50-100		020905	006105
50-120	288	020906	006106
90-155		020907	006107
115-170	310	020909	006109
120-180		020910	006110
125-150		020914	006114

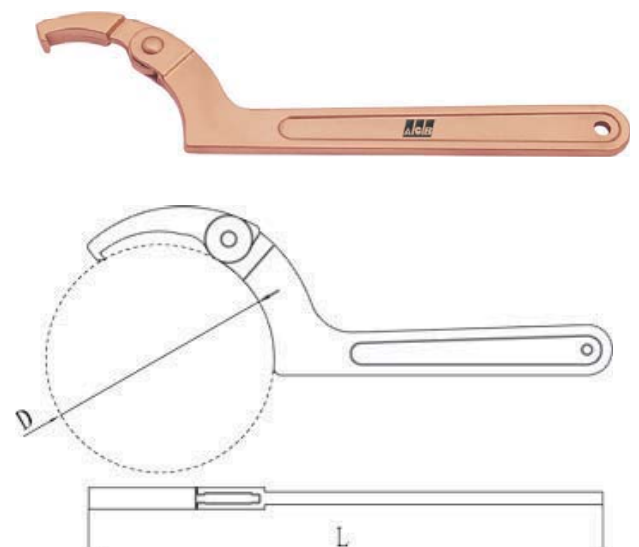

MASSES / MARTEAUX

HAMMERS SLEDGE / CLUB HAMMERS
FÄUSTEL / HAMMERS
ACOTILLO / MARTILLO



ANTIDÉFLAGRANT
ANTIMAGNÉTIQUE
SAFETYTOOLS

www.adf-safetytools.com

ANTIDÉFLAGRANT
ANTIMAGNÉTIQUE
SAFETYTOOLS

www.adf-safetytools.com

MARTEAU DE CHARPENTIER

Hammer, claw / Klauenhammer / Martillo con Garra

H o	L mm	g	Alliage / Alloy	
			Al-Br	Be-Cu
230	280	405	018300	003500
450	300	652	018301	003501
680	330	933	018305	003505
910	390	1205	018307	003500



MARTEAU DE CHARPENTIER 2

MARTEAU DE CHARPENTIER 2

Carpenter's Hammer

H o	L mm	Alliage / Alloy	
		Al-Br	Be-Cu
500	300	018310	003510
600	330	018312	003512



MARTEAU TESTEUR

MARTEAU TESTEUR

Hammer, Testing

H o	L mm	Alliage / Alloy	
		Al-Br	Be-Cu
150	300	089800	089900
250	335	089801	089901



MARTEAU DE CHARPENTIER

MARTEAU DE MAÇON

Hammer, bricklayer's / Maurerhammer / Martillo de Albanil

H o	L mm	g	Alliage / Alloy	
			Al-Br	Be-Cu
600	305	750	017301	002401
800	340	1000	017303	002403

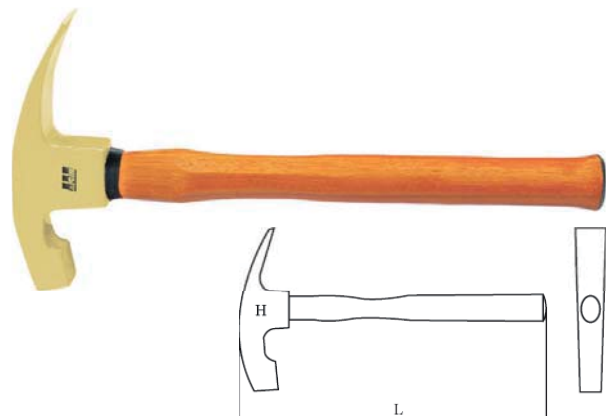



MARTEAU À PIQUER

Hammer, scaling / Entrostungshammer / Martillo Burilador



H g	L mm	Alliage / Alloy	
		Al-Br	Be-Cu
150	280	016601	001701
300	280	016608	001708
400	350	016602	001702
700	380	016603	001703
900	400	016604	001704

MARTEAU DE MÉCANICIEN, DIN 1041

MARTEAU DE MÉCANICIEN, DIN 1041

Hammer, cross pein engineer's / Schlosserhammer, DIN1041 / Martillo de Ingeniero de Golpe Cruzado

L mm	H mm	Ø mm	Alliage / Alloy	
			Al-Br	Be-Cu
100	280	180	016201	001301
200	300	300	016202	001302
300	300	425	016203	001303
500	310	655	016204	001304
800	310	955	016205	001305
1000	340	1175	016206	001306
1500	400	1850	016207	001307
2000	450	2455	016208	001308
3000	700	3700	016209	001309
5000	900	6000	016210	001310



www.adf-safetytools.com



ANTIDÉFLAGRANT
ANTIMAGNÉTIQUE
SAFETYTOOLS

www.adf-safetytools.com

MARTEAU DE MÉCANICIEN, TYPE AMÉRICAIN

Hammer, ball pein / Schlosserhammer, amerikanische Form / Martillo de Ingeniero

H g	L mm	g	Alliage / Alloy	
			Al-Br	Be-Cu
230	280	403	016007	001107
340	280	502	016008	001108
450	310	680	016009	001109
680	340	950	016010	001110
910	350	1205	016011	001111
1130	400	1470	016012	001112

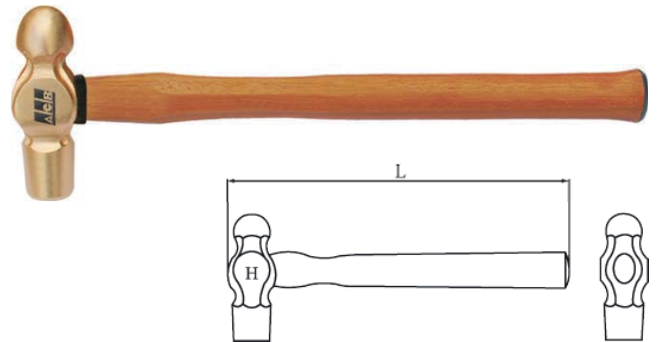

MASSE À PANS TYPE ALLEMAND

MASSE À PANS, TYPE ALLEMAND

Hammer, sledge, German type / Fäustel, DIN 6475 / Acotillo



H g	L mm	Alliage / Alloy	
		Al-Br	Be-Cu
800	400	016400	001500
1000	400	016401	001501
1500	400	016402	001502
2000	400	016403	001503
2500	700	016425	001525
3000	700	016404	001504
4500	900	016445	001545
5000	900	016406	001506
6400	900	016407	001507
8000	900	016408	001508
9900	900	016409	001509

MASSE À PANS

MASSE À PANS

Hammer, sledge / Fäustel, amerikanische Form / Acotillo

H g	L mm	Alliage / Alloy	
		Al-Br	Be-Cu
450	310		
800	400	016300	001400
1000	400	016301	001401
1500	400	016302	001402
2000	400	016307	001407
2500	700	016303	001403
3000	700	016304	001404
4000	900		



H g	L mm	Alliage / Alloy	
		Al-Br	Be-Cu
4500	900	016309	001409
5000	900	016305	001405
5400	900		
6400	900	016312	001412
8000	900	016306	001406
9900	900	016310	001410

MARTEAU CLUB HAMMER

MARTEAU

Club Hammer

Size lb	Alliage / Alloy	
	Al-Br	Be-Cu
2		
4		



BURINS / COINS / BROCHES

CHISELS / WEDGES / PUNCH

MEISSEL / FLANSCHKEIL / SPLINTTREIBER

CINCEL / CUNA / BOTADOR

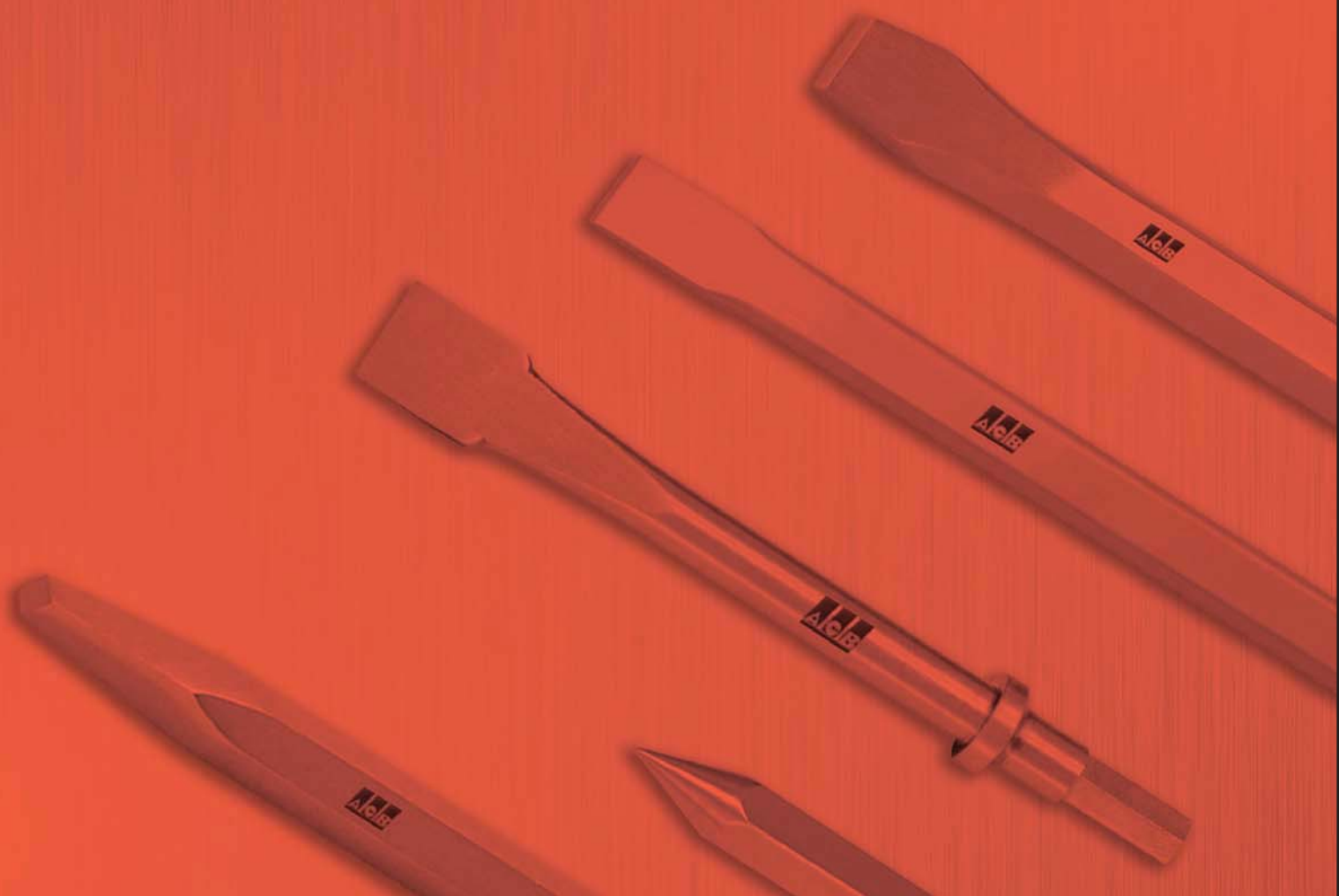

ANTIDÉFLAGRANT
ANTIMAGNÉTIQUE
SAFETYTOOLS

www.adf-safetytools.com

ANTIDÉFLAGRANT
ANTIMAGNÉTIQUE
SAFETYTOOLS

www.adf-safetytools.com

COIN, CASSE JOINT

Wedge, flange / Flanschkeil / Cuna de Pestana

L mm	B mm	H mm	Alliage / Alloy	
			Al-Br	Be-Cu
80	13	6	025816	013016
100	50	10	025804	013004
135	50	18	025806	013006
150	25	8	025808	013008
150	25	13	025810	013010
150	40	8	025812	013012
150	50	13	025814	013014
180	32	13	025818	013018
180	50	19	025820	013020
200	20	30	025822	013022
200	30	30	025824	013024
200	40	40	025826	013026
200	50	12	025828	013028
230	40	20	025830	013030
250	40	30	025832	013032
300	50	40	025834	013034



BÉDANE

BÉDANE

Chisel, groove / Nutenmeißel / Cincel de Ranura

S mm	L mm	H mm	Alliage / Alloy	
			Al-Br	Be-Cu
11	150	4	022011	007411
18	150	6	022015	007415
20	200	8	022020	007420
23	300	10	022030	007430

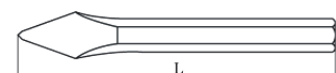



BURIN PLAT

Chisel Flat / Meißel Flach / Cortafrio

B mm	L mm	Alliage / Alloy	
		Al-Br	Be-Cu
14	100	021905	007305
22	150	021910	007310
22	200	021920	007320
24	250	021925	007325
25	300	021930	007330
27	400	021940	007340

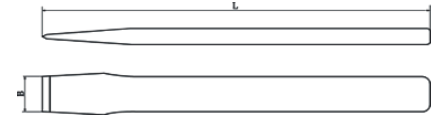

BURIN POINTE DE DIAMANT

BURIN POINTE DE DIAMANT

Chisel, diamond point / Diamantspitzmeißel / Cincel punta de Diamante

S mm	B mm	S mm	Alliage / Alloy	
			Al-Br	Be-Cu
200	13	20	022520	008020
250	13	20	022525	008025
300	15	22	022530	008030
400	15	22	022540	008040

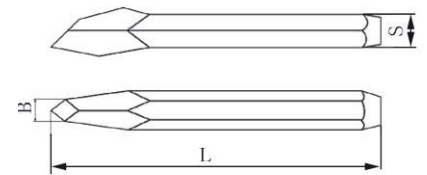

CHASSE-GOUPILLE CYLINDRIQUE

BURIN HEXAGONAL

Chisel Hex / Meißel Hex / Cincel Hex

S mm	L mm	B mm	Alliage / Alloy	
			Al-Br	Be-Cu
10	150	12	022302	007702
14	200	16	022304	007703
16	160	18	022306	007706
14	250	16	022308	007708
17	300	19	022310	007710
17	350	19	022312	007712
22	600	24	022314	007714
25	300	28	022316	007716
30	500	35	022318	007718

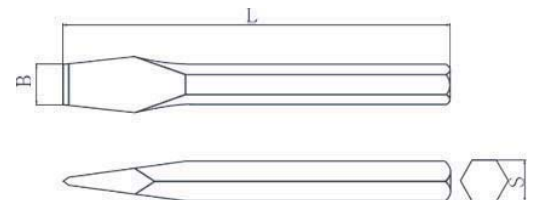

ANTIDÉFLAGRANT
ANTIMAGNÉTIQUE
SAFETYTOOLS

www.adf-safetytools.com

CHASSE-GOUPILLE CYLINDRIQUE

Pin punch / Splinttreiber DIN 6450 / Botador

Ø mm	L mm	Alliage / Alloy	
		Al-Br	Be-Cu
2	110	021702	006902
3	110	021703	006903
4	110	021704	006904
5	110	021705	006905
6	115	021706	006906
7	120	021707	006907
8	120	021708	006908
10	145	021710	006910
12	160	021712	006912
14	180	021714	006914
16	200	021716	006916
18	225	021718	006918

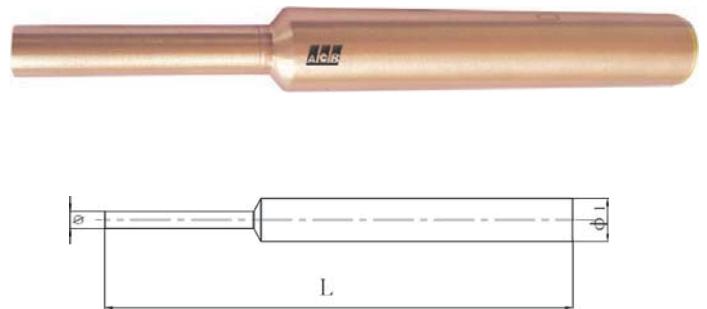

CHASSE-GOUPILLE CÔNIQUE

CHASSE-GOUPILLE CÔNIQUE

Hunting conical pin / Jagd konischen stift / Perno cónico de caza

L mm	Ø mm	Ø1 mm	Alliage / Alloy	
			Al-Br	Be-Cu
150	4		021804	007004
150	5		021805	007005
150	6		021806	007006
150	7		021807	007007
150	8		021808	007008
150	9		021809	007009
150	10	13	021810	007010
150	11		021811	007011
150	12	15	021812	007012
150	13		021813	007013
200	14	18	021814	007014
200	15	19	021815	007015
200	16	20	021816	007016
200	17	21	021817	007017
250	18	22	021818	007018
250	19	23	021819	007019
250	20	24	021820	007020
250	21	25	021821	007021
250	22	26	021822	007022

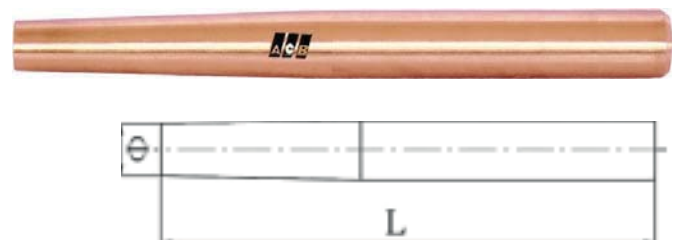

L mm	B mm	H mm	Alliage / Alloy	
			Al-Br	Be-Cu
250	23		021823	007023
250	24	28	021824	007024
250	25	29	021825	007025
250	26	30	021826	007026
300	27	31	021827	007027
300	28		021828	007028
300	29		021829	007029
300	30		021830	007030
300	33		021833	007033



POINTEAU

Punch

Ø mm	Ø1 mm	l mm	Alliage / Alloy	
			Al-Br	Be-Cu
5	11	150	087605	087705
6	12	150	087606	087706
7	13	150	088707	087707
8	14	150	087608	087708
10	16	175	087610	087710
12	18	175	087612	087712
13	29	255	087613	087713



POINTEAU

POINTEAU

Punch

L mm	S mm	Alliage / Alloy	
		Al-Br	Be-Cu
100	16	083601	007201
150	16	083602	007202
200	18	083603	007203
300	18	083605	007205
400	18	083606	007206
500	20	083608	007208

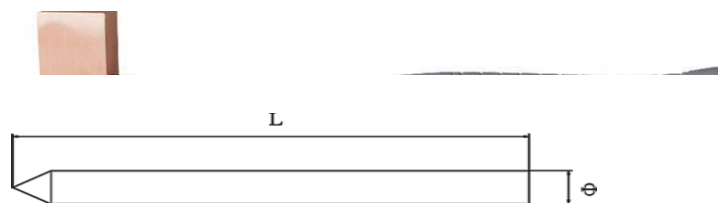

POINTE DE MACON

POINTE DE MAÇON

Punch, Machinists

S mm	L mm	Alliage / Alloy	
		Al-Br	Be-Cu
14	150	083414	079014
18	200	083418	079018
20	250	083420	079020
20	300	083422	079022

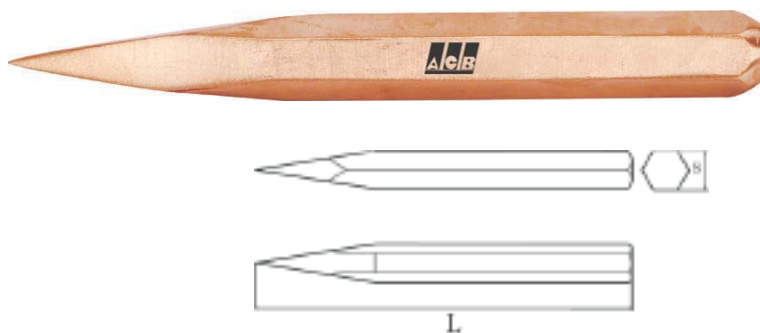



ANTIDÉFLAGRANT
ANTIMAGNÉTIQUE
SAFETYTOOLS

www.adf-safetytools.com

BURIN PNEUMATIQUE

Chisel, pneumatic Bull Point / Pneumatischer meißel / Buril neumatico

S mm	L mm	B mm	H mm	Alliage / Alloy	
				Al-Br	Be-Cu
10	125	20	2	022236	000336
10	175	20	2	022238	000338

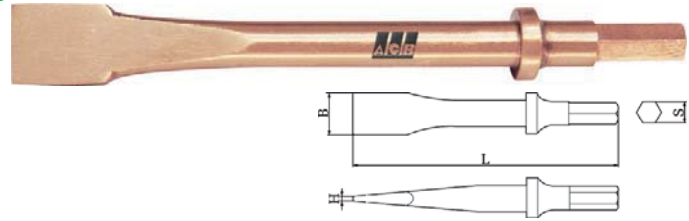

BURIN PNEUMATIQUE

BURIN PNEUMATIQUE

Chisel, pneumatic Bull Point / Pneumatischer meißel / Buril neumatico

S mm	L mm	B mm	Alliage / Alloy	
			Al-Br	Be-Cu
10	125	20	022230	000330
10	175	20	022232	000332

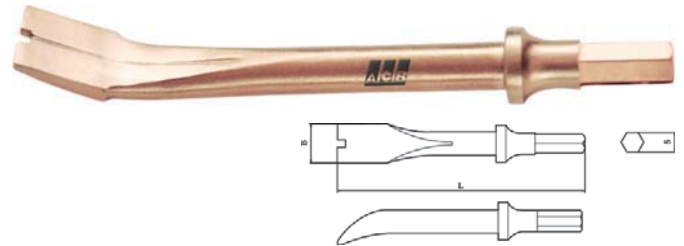

BURIN PNEUMATIQUE

BURIN PNEUMATIQUE

Chisel, pneumatic Bull Point / Pneumatischer meißel / Buril neumatico

S mm	L mm	B mm	H mm	Alliage / Alloy	
				Al-Br	Be-Cu
10	125	20	2	022236	000336
10	175	20	2	022238	000338

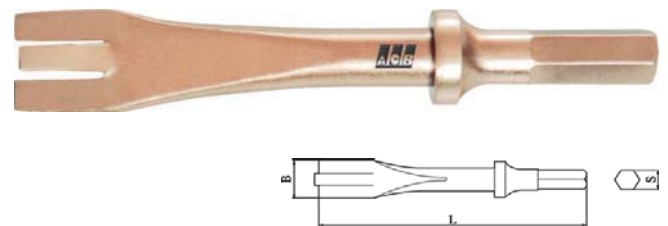

BURIN PNEUMATIQUE

BURIN PNEUMATIQUE

Chisel, pneumatic Bull Point / Pneumatischer meißel / Buril neumatico

S mm	L mm	B mm	H mm	Alliage / Alloy	
				Al-Br	Be-Cu
10	125	20	2	022242	000342
10	175	20	2	022244	000344

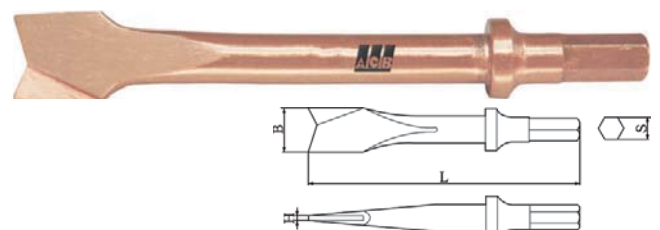



BURIN PNEUMATIQUE

Chisel, pneumatic Bull Point / Pneumatischer meißel / Buril neumatico

S mm	L mm	B mm	Alliage / Alloy	
			Al-Br	Be-Cu
10	125	20	022230	000330
10	175	20	022232	000332

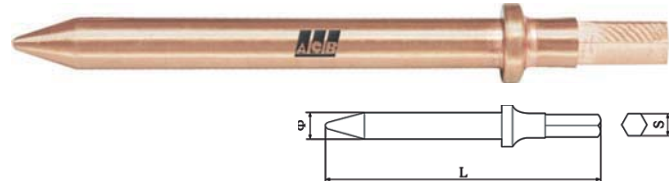

PINCE À DÉCOFFRER

OUVRE-CAISSE

Crate opener / Verschlagöffner / Abre Cajas

L mm	O mm	Alliage / Alloy	
		Al-Br	Be-Cu
230	70	081002	076602

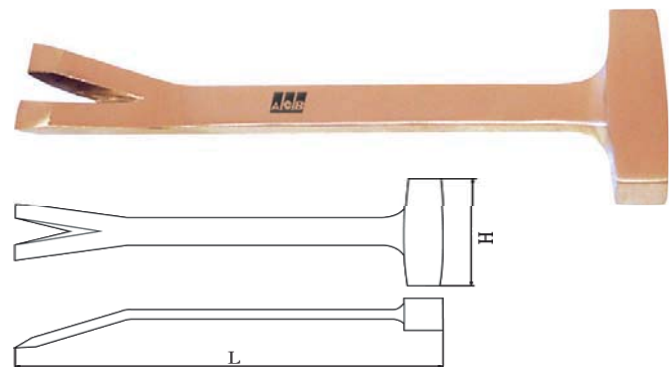

PINCE À DÉCOFFRER

PINCE À DÉCOFFRER

Bar, wrecking / Nageleisen mit Klaue / Barra de Demolicion

L mm	O mm	Alliage / Alloy	
		Al-Br	Be-Cu
400	16	026320	029620
600	16	026322	029622
800	19	026324	029624
1200	20	026326	029626

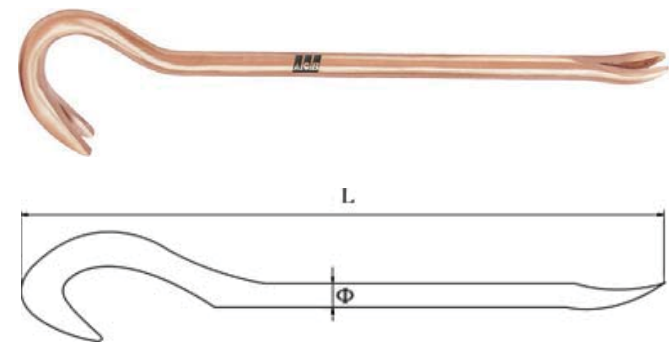

PINCE À DÉCOFFRER

PINCE À DÉCOFFRER

Bar, wrecking / Nageleisen mit Klaue / Barra de Demolicion

L mm	Ø mm	B mm	H mm	Alliage / Alloy	
				Al-Br	Be-Cu
250	13	15	1,5	026302	029602

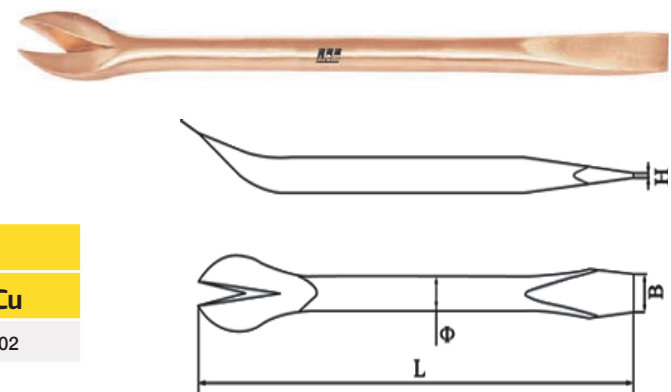



ANTIDÉFLAGRANT
ANTIMAGNÉTIQUE
SAFETYTOOLS

www.adf-safetytools.com

PINCE À DÉCOFFRER HEXAGONAL

Bar, wrecking Hex

L mm	Ø mm	Alliage / Alloy	
		Al-Br	Be-Cu
460	16	026346	059346
760	22	026376	059376
920	22	026392	059392

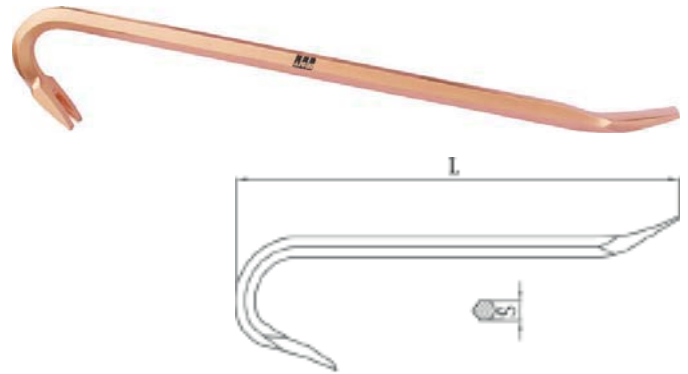

PINCE À TALON

PINCE À TALON

Bar, pinch / Brechstanger / Barra Pie de Cabra

L mm	Ø mm	B mm	Alliage / Alloy	
			Al-Br	Be-Cu
500	20	20	026108	013308
800	23	23	026111	013311
1000	30	28	026114	013314

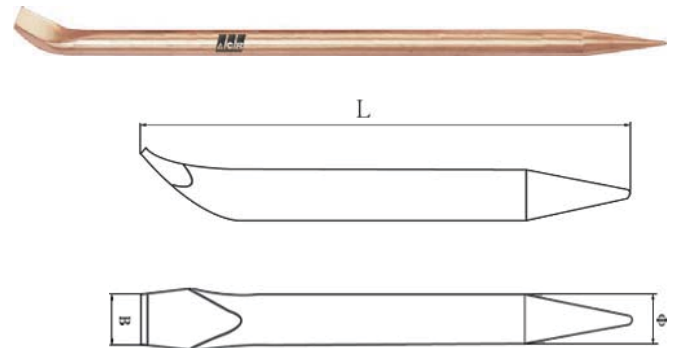

PINCE À TALON

PINCE À TALON

Bar, pinch / Brechstanger / Barra Pie de Cabra

L mm	Ø mm	B mm	Alliage / Alloy	
			Al-Br	Be-Cu
500	20	20	026132	013332
800	23	23	026137	013337
1000	30	30	026143	013343
1500	30	30	026146	013346

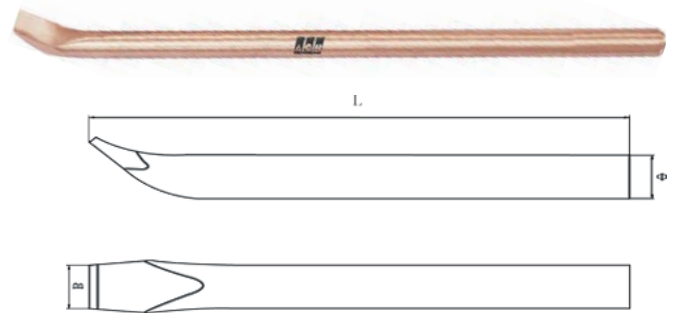

PINCE À TALON

PINCE À TALON

Bar, pinch / Brechstanger / Barra Pie de Cabra

L mm	Ø mm	B mm	Alliage / Alloy	
			Al-Br	Be-Cu
600	3	52	026160	013360

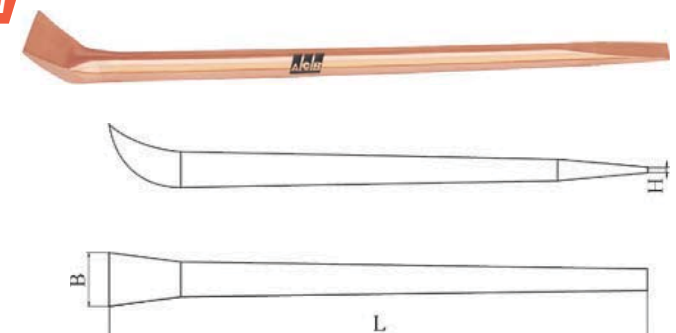



PINCE À TALON HEXAGONALE

Bar Hex Pinch

L mm	Ø mm	B mm	Alliage / Alloy	
			Al-Br	Be-Cu
500	18	20	059420	059520
500	20	22	059422	059522
600	20	22	059423	059523
1000	22	24	059424	059524
1000	25	27	059427	059527
1000	35	37	059437	059537
1500	25	27	059428	059528

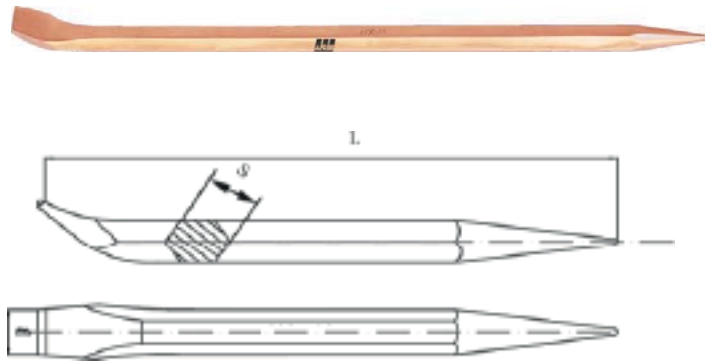

ALÈNE

PINCE À LEVIER

Bar, crow / Hebestange / Barra Pata de Gallo

L mm	B mm	Alliage / Alloy	
		Al-Br	Be-Cu
1500	30	028702	076702

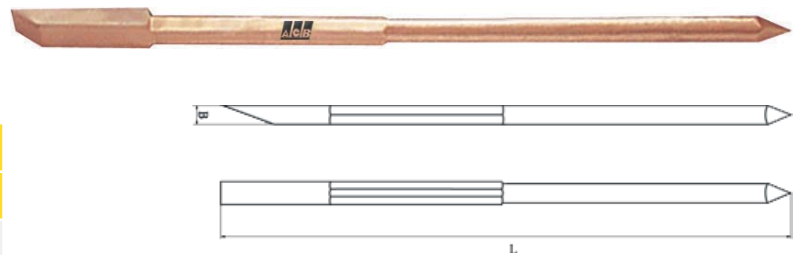

ALÈNE

ALÈNE

Awl / Vorstecher / Lesna

L inch	L ₁ mm	Ø mm	L mm	Alliage / Alloy	
				Al-Br	Be-Cu
4	100	3	184	081303	076903

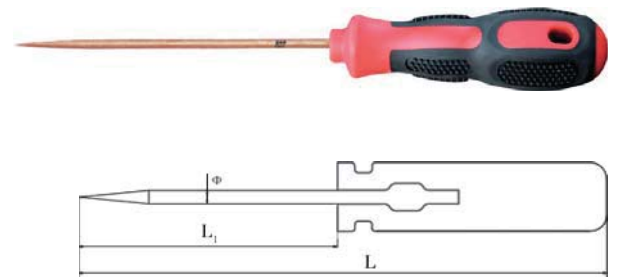

POINTE À TRACER

POINTE À TRACER

Double-end sciber / Reissnadel / Rayador de Doble Extremo

L mm	H mm	Ø mm	Alliage / Alloy	
			Al-Br	Be-Cu
187	32	4	081201	007101
252	42	4	081203	007103

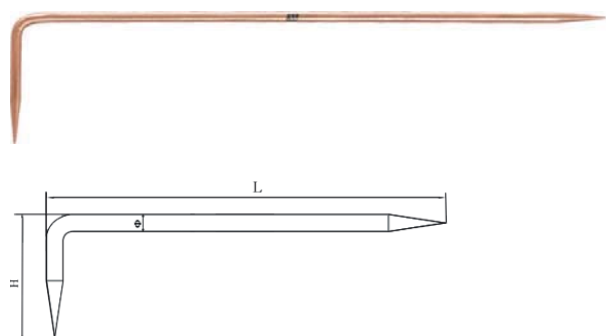



ANTIDÉFLAGRANT
ANTIMAGNÉTIQUE
SAFETYTOOLS

www.adf-safetytools.com

HACHE DE POMPIER

Axe, pick head / Feuerwehraxt / Hacha de Bombero

L mm	H mm	B mm	Alliage / Alloy	
			Al-Br	Be-Cu
340	200	98	026001	013201



HACHE DE CHARPENTIER

HACHE DE CHARPENTIER

Hatchet / Beil / Hachuela

L mm	H mm	B mm	Alliage / Alloy	
			Al-Br	Be-Cu
340	145	82	025901	013101



PINCES / PINCES MULTIPRISES / TENAILLES

PLIERS / PLIERS GROOVE JOINT / PLIERS CUTTING
ZANGE / WASSERPUMPENZANGE / BEIBZANGE
ALICATE / PINZA JUNTA ESTRILA / PINZA CORTADORA



ANTIDÉFLAGRANT
ANTIMAGNÉTIQUE
SAFETYTOOLS

www.adf-safetytools.com



ANTIDÉFLAGRANT
ANTIMAGNÉTIQUE
SAFETYTOOLS

www.adf-safetytools.com

PINCE MULTIPRISE

Pliers, groove joint / Wasserpumpenzange / Pinza Junta Estrila

L inch	L mm	K _{max} mm	Alliage / Alloy	
			Al-Br	Be-Cu
6"	150	25	024500	010300
10"	250	45	024501	010301
12"	300	55	024502	010302
14"	350	55	024503	010303

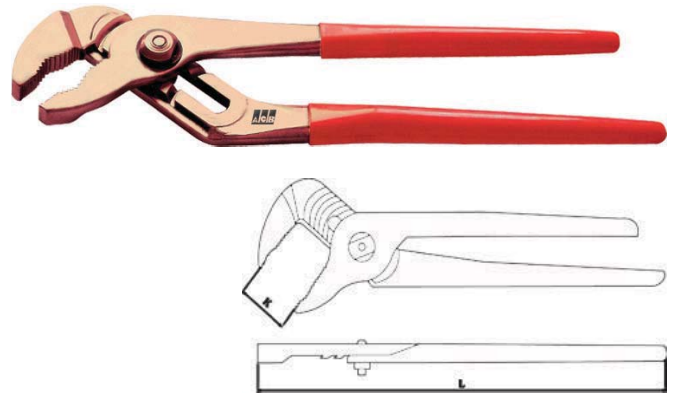

PINCE MULTIPRISE DOUBLE CRÉMAILLIÈRE

PINCE MULTIPRISE DOUBLE CRÉMAILLIÈRE

Pliers, groove joint / Wasserpumpenzange / Pinza Junta Estrila

L inch	L mm	K _{max} mm	Alliage / Alloy	
			Al-Br	Be-Cu
10"	250	32	024510	010310

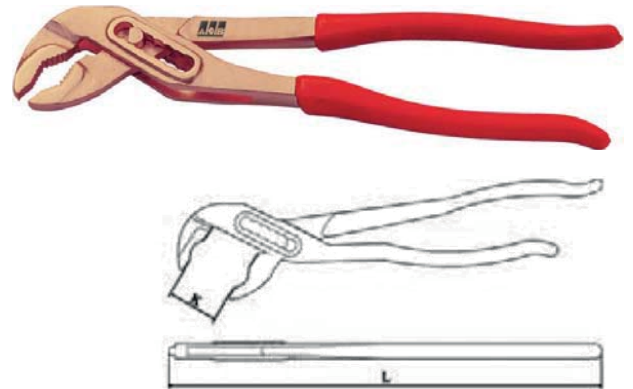

PINCE UNIVERSELLE COUPANTE

PINCE UNIVERSELLE COUPANTE

Pliers, combination, with cutter / Kombinationszange, DIN 5244
/ Alicate Universal

L inch	L mm	Alliage / Alloy	
		Al-Br	Be-Cu
6"	150	025300	011102
7"	175	025302	011103
8"	200	025301	011101
10"	250	025303	011104

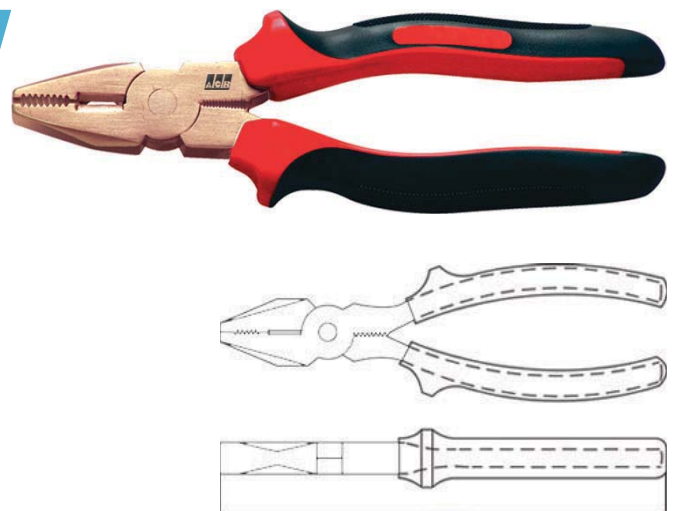



PINCE COMBINÉE

Pliers, adjustable combination / Verstellbare Kombinationszange / Alicata Ajustable

L inch	L mm	K mm	Alliage / Alloy	
			Al-Br	Be-Cu
8"	200	13	024601	010401



PINCE COUPANTE DIAGONALE

PINCE COUPANTE DIAGONALE

Pliers, diagonal cutting / Seitenschneider, DIN 5238 / Alicata de Corte Diagonal

L inch	L mm	Alliage / Alloy	
		Al-Br	Be-Cu
6"	150	024201	010001
8"	200	024203	010002

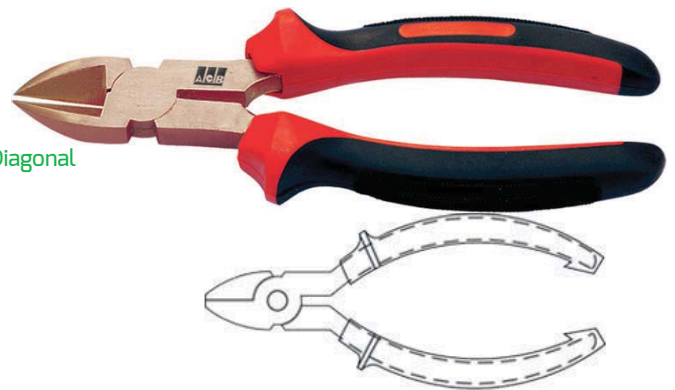

TENAILLE

TENAILLE

Pliers, cutting / BeiBzange, Din 5241 / Pinza Cortadora

L inch	L mm	Alliage / Alloy	
		Al-Br	Be-Cu
8"	200	024401	010201

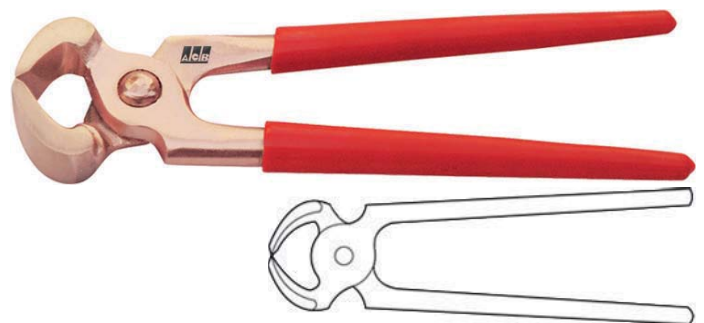

TENAILLE RUSSE

TENAILLE RUSSE

Pincers

L inch	L mm	Alliage / Alloy	
		Al-Br	Be-Cu
7"	175	057807	057907



PINCE À GAZ

PINCE À GAZ

Gas pliers

L mm	Alliage / Alloy	
	Al-Br	Be-Cu
200	057620	057720

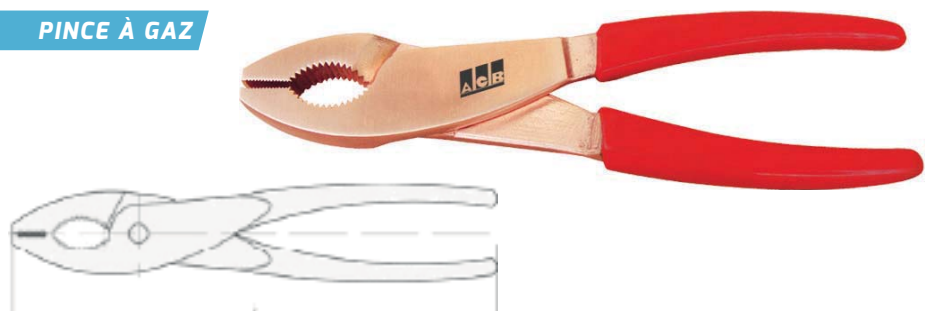



ANTIDÉFLAGRANT
ANTIMAGNÉTIQUE
SAFETYTOOLS

www.adf-safetytools.com

PINCE PLATE

Pliers, flat nose / Flachzange, DIN 5248 / Alicate de Punta Aplanada

L inch	L mm	Alliage / Alloy	
		Al-Br	Be-Cu
6"	150	024701	010501
8"	200	024703	010503



PINCE PLATE À BECS COURTS

PINCE PLATE À BECS COURTS

L inch	L mm	K _{max} inch	Alliage / Alloy	
			Al-Br	Be-Cu
6"	150	54	037206	036906

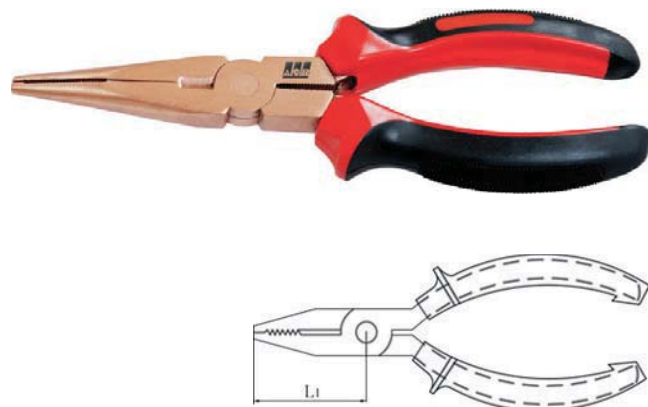

PINCE PLATE À BECS COURTS

PINCE PLATE À BECS LONGS

L inch	L mm	L ₁ inch	Alliage / Alloy	
			Al-Br	Be-Cu
6"	150	54	025200	011000
8"	200	74	025201	011001

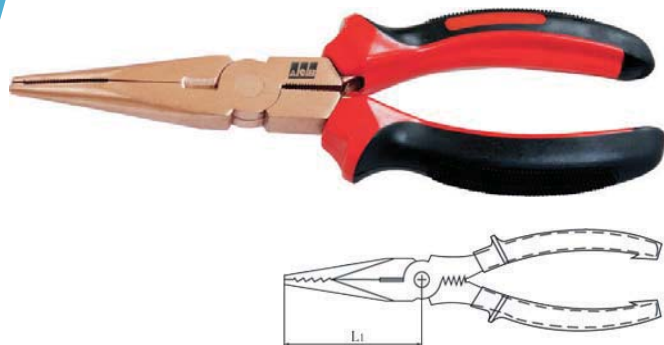

PINCE PLATE A BECS COUDÉS 45°

PINCE PLATE A BECS COUDÉS 45°

Pliers, nose 45 degree bent

L inch	L mm	Alliage / Alloy	
		Al-Br	Be-Cu
6"	150		

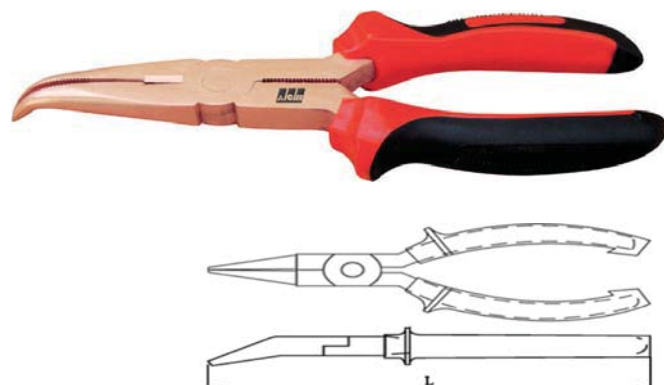



PINCE À BECS RONDS

Pliers, round nose / Rundzange, DIN 5249 / Alicates, Bocas Redondas

L inch	L mm	Alliage / Alloy	
		Al-Br	Be-Cu
6"	150	024801	010601

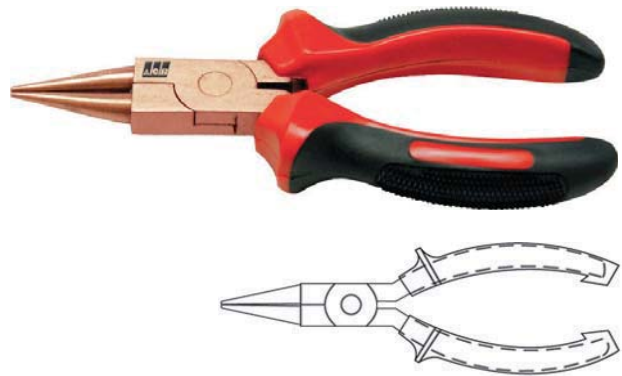

PINCE À SERTIR LES COSSES

PINCE À DENUDER

Wire stripping pliers

L mm	Alliage / Alloy	
	Al-Br	Be-Cu
200	059620	059720

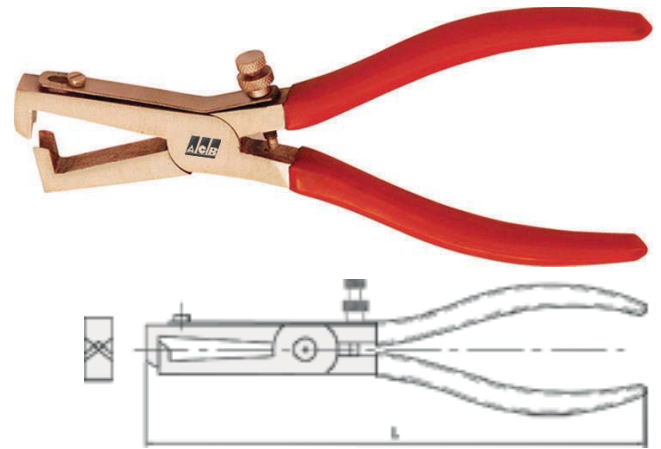

PINCE ÉTAU

PINCE ÉTAU

Locking pliers

Size inch	L mm	D mm	Alliage / Alloy	
			Al-Br	Be-Cu
10"	226	40		

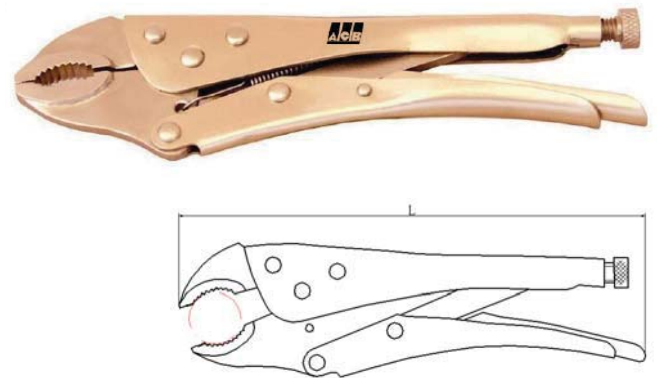

PINCE À SERTIR LES COSSES

PINCE À SERTIR LES COSSES

Universal crimping pliers / Kombi-PreB und kerbzange / Alicates para terminales

L inch	L mm	Alliage / Alloy	
		Al-Br	Be-Cu
8"	200	082608	078208

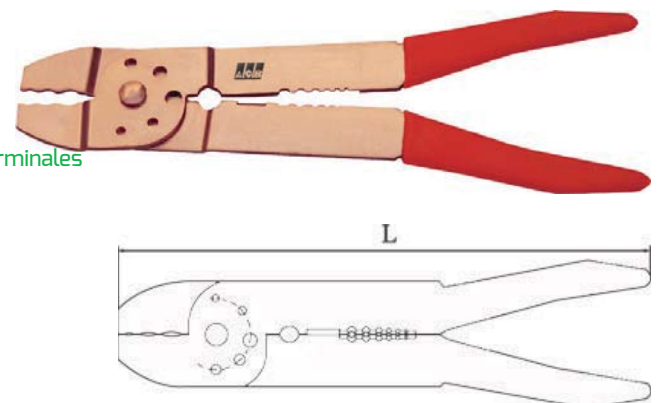



**ANTIDÉFLAGRANT
ANTIMAGNÉTIQUE
SAFETYTOOLS**

www.adf-safetytools.com

PINCETTE

Tweezers / Pinzette / Pinzetta

L mm	Alliage / Alloy	
	Al-Br	Be-Cu
150	025100	010900
200	025101	010901

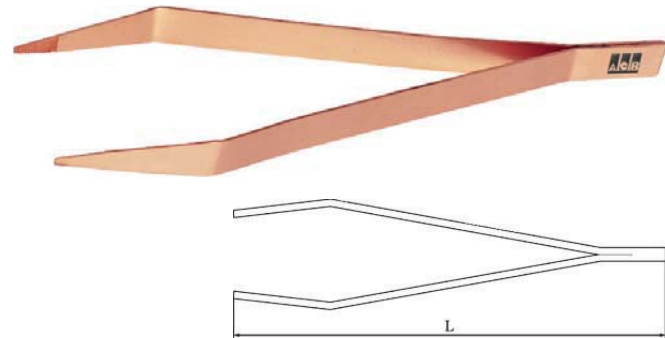

PAIRE DE CISEAUX

PAIRE DE CISEAUX

Shears, cutting / Schere / Tijeras

L inch	L mm	B mm	Alliage / Alloy	
			Al-Br	Be-Cu
9"	225	98	059801	010801

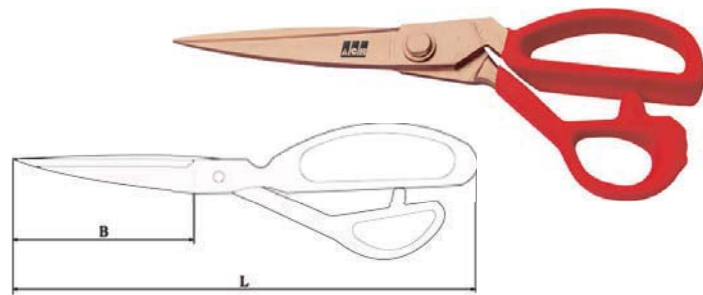



CISAILLE À TÔLE

L mm	B mm	Alliage / Alloy	
		Al-Br	Be-Cu
300	75	-	010703

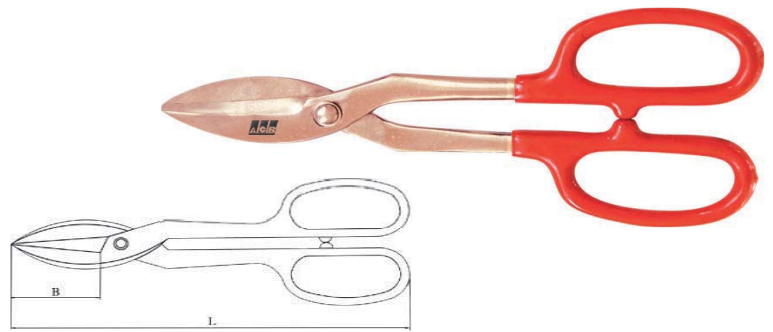

CISAILLE À TÔLE

CISAILLE À TÔLE

L mm	Alliage / Alloy	
	Al-Br	Be-Cu
275	-	010701

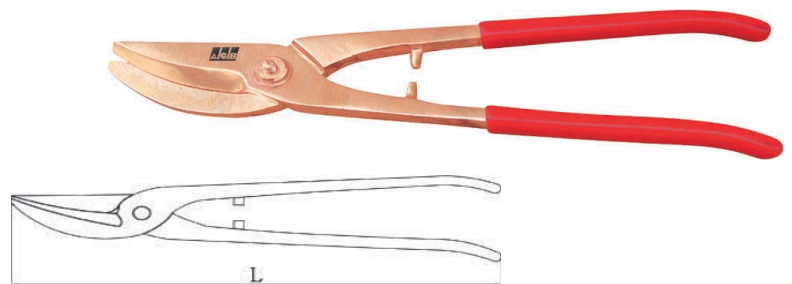



ANTIDÉFLAGRANT
ANTIMAGNÉTIQUE
SAFETYTOOLS

www.adf-safetytools.com

PINCE POUR CIRCLIPS EXTÉRIEURS

Pliers, snap ring, outside / Sicherungsringzange (Auben), DIN 5254 / Pinza Abre Anillos exteriores

L inch	L mm	Alliage / Alloy	
		Al-Br	Be-Cu
8"	200	038908	038308
10"	250	038910	038310

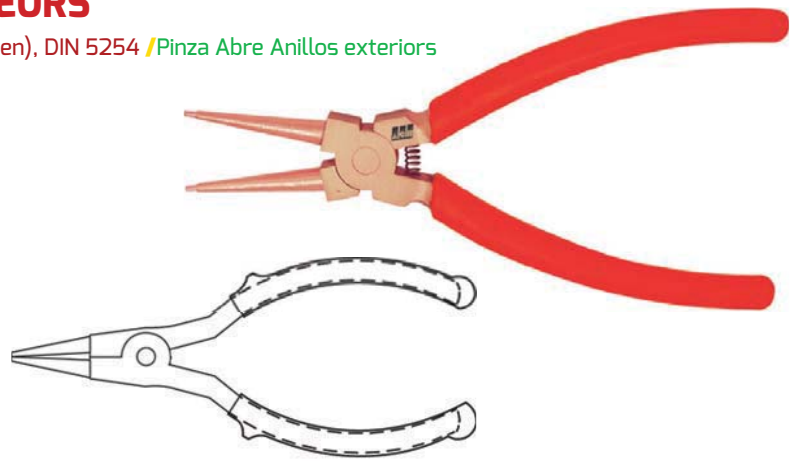

PINCE POUR CIRCLIPS INTÉRIEURS

PINCE POUR CIRCLIPS INTÉRIEURS

Pliers, snap ring, inside / Sicherungsringzange (Innen), DIN 5254 / Pinza Abre Anillos Interiors

L inch	L mm	Qualité	
		Al-Br	Be-Cu
8"	200	038808	038208
10"	250	038810	038210

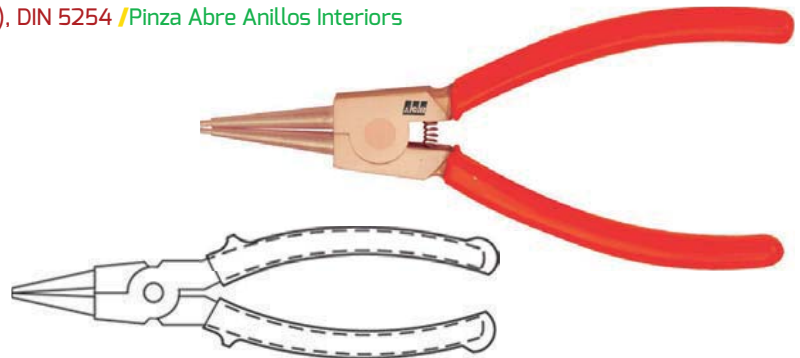

PINCE COUPE-BOULONS

PINCE COUPE-BOULONS

Bolt Chipper

L mm	D mm	Qualité	
		Al-Br	Be-Cu
600	6	059906	060006
900	8	059908	060008

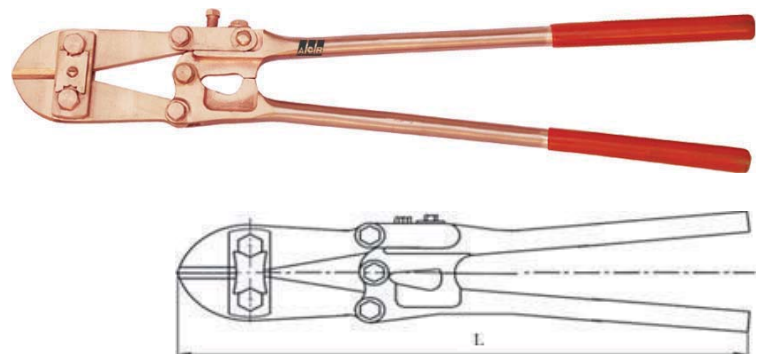

TOURNEVIS / TOURNEVIS PH / PZ / TORX

SCREWDRIVERS / SCREWDRIVERS PH / PZ / TORX

SCHRAUBENDREHER / SCHRAUBENDREHER PH / PZ / TORX

DESTORNILLADOR / DESTORNILLADOR PH / PZ / TORX

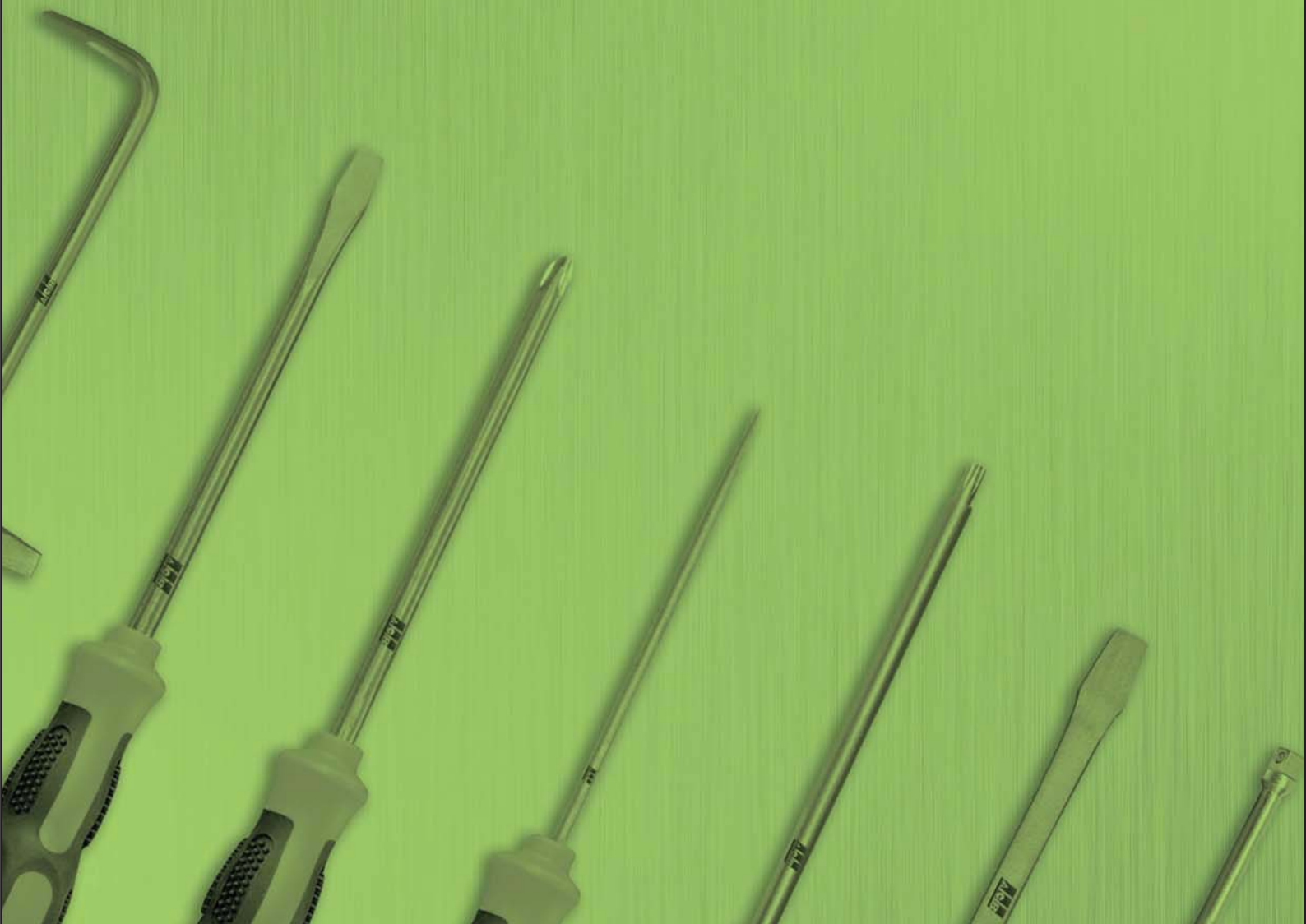

ANTIDÉFLAGRANT
ANTIMAGNÉTIQUE
SAFETYTOOLS

www.adf-safetytools.com



ANTIDÉFLAGRANT
ANTIMAGNÉTIQUE
SAFETYTOOLS

www.adf-safetytools.com

TOURNEVIS PLAT

Screwdriver / Schlitz-Schraubendreher / Destornillador, Hoja Cilindrica

L ₁ inch	L mm	H mm	B inch	Alliage / Alloy
				Be-Cu
50	108	0,5	4	011405
75	159	0,5	4	011403
100	184	0,5	4	011408
180	190	0,5	4	011421
150	265	1	7	011414
150	277	1,2	8	011416
200	327	1,2	8	011417
250	377	2	11	011420
300	427	2	11	011423

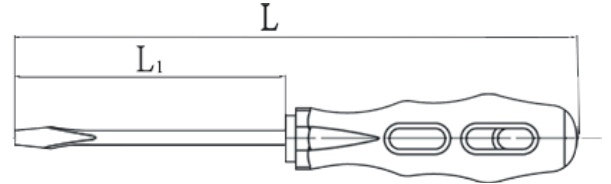

TOURNEVIS PHILLIPS

TOURNEVIS PHILLIPS

Screwdriver, Phillips type / Kreuzschlitz-Schraubendreher / Destornillador Philips

S mm	L ₁ mm	L mm	Alliage / Alloy
			Be-Cu
1	75	159	011601
2	100	184	011602
3	150	243	011603
4	150	243	011610
4	200	305	011604
6	200	315	011614

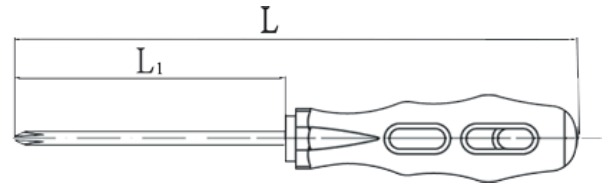

TOURNEVIS POZIDRIV

TOURNEVIS POZIDRIV

Screwdriver, Pozidriv type / Schraubendreher Posidriv / Destornillador Posidriv

S mm	L ₁ mm	L mm	Alliage / Alloy
			Be-Cu
0	50	134	079700
1	75	159	079701
2	100	220	079702
3	150	277	079703
4	200	327	079704

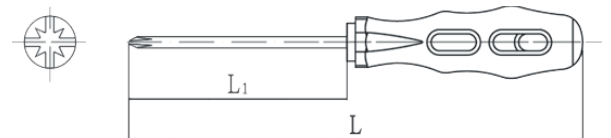



TOURNEVIS D'ELECTRICIEN

Electrician screwdriver

L ₁ inch	L ₁ mm	L mm	H mm	B inch	Alliage / Alloy
					Be-Cu
2	50	134	0.4	3	107704
4	100	184	0.5	4	107709
4	100	215	0.8	6	107710
6	150	277	1.2	8	107708
8	200	327	1.8	10	107711

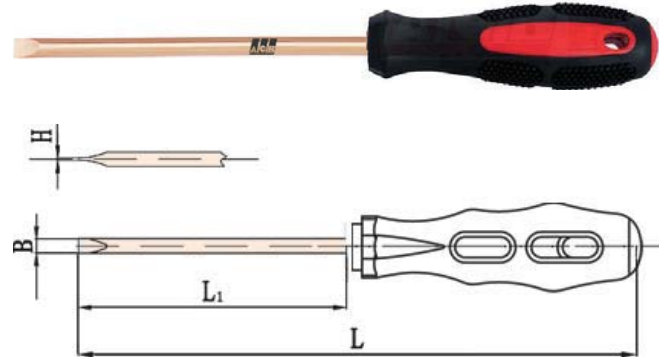

TOURNEVIS TORX

TOURNEVIS TORX

Manquant

L ₁ inch	L ₁ mm	L mm	H mm	B inch	Alliage / Alloy
					Be-Cu
T10					080110
T15					080112
T20					080114
T25					080116
T30					080118
T40					080120
T45					080122
T50					080124
T55					080126
T60					080128

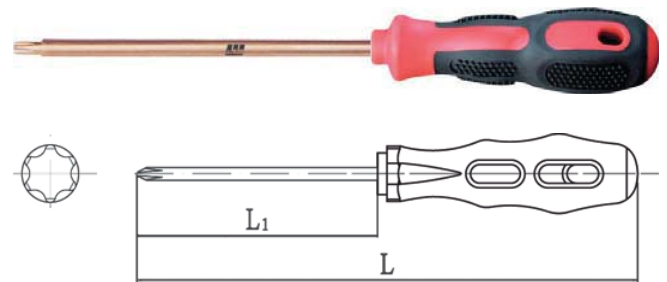

www.adf-safetytools.com



+33 (0) 3 27 78 01 02



+33 (0) 3 27 78 10 11



contact@adf-safetytools.com

ANTIDÉFLAGRANT
ANTIMAGNÉTIQUE
SAFETYTOOLS

www.adf-safetytools.com

TOURNEVIS À LAME PLATE

Screwdriver / Schraubendreher / Destornillador, Hoja Plana



S mm	L ₁ mm	L mm	Alliage / Alloy
			Be-Cu
200	100	8	076402
300	160	10	076406

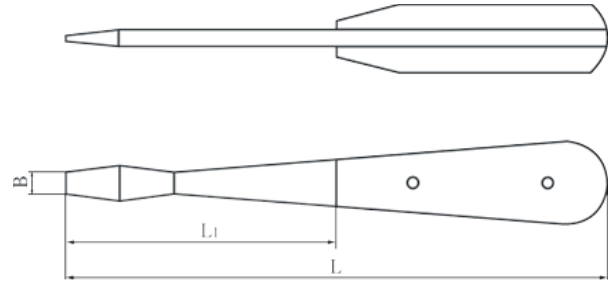

TOURNEVIS COUDÉ

TOURNEVIS COUDÉ

Screwdriver, offset / Winkelschraubendreher / Destornillador Acodado

L mm	H mm	K mm	Alliage / Alloy
			Be-Cu
72	1	6	011504
125	1,5	8	011505
196	1,5	10	011506

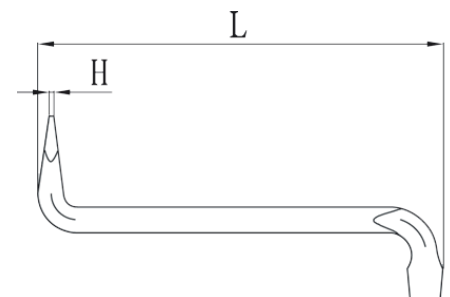

www.adf-safetytools.com



GRATTOIRS / BROSSES / LIMES

SCRAPERS / BRUSHES / FILES
SCHABER / BÜRSTE / KALK
RASPADOR / CEPILLO / LIMA



ANTIDÉFLAGRANT
ANTIMAGNÉTIQUE
SAFETYTOOLS

www.adf-safetytools.com



ANTIDÉFLAGRANT
ANTIMAGNÉTIQUE
SAFETYTOOLS

www.adf-safetytools.com

GRATTOIR COUDÉ

Scraper, deck / Winkelschaber / Raspador Elevado

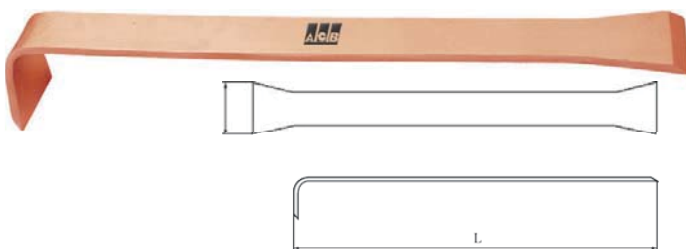

D mm	K mm	Alliage / Alloy	
		Al-Br	Be-Cu
250	39	022900	008300
300	45	022904	008304
350	55	022901	008301
400	50	022903	008303
650	56	022905	008305
700	58	022907	008307

GRATTOIR COUDÉ

GRATTOIR COUDÉ

Scraper, deck / Winkelschaber / Raspador Elevado

D mm	K mm	Alliage / Alloy	
		Al-Br	Be-Cu
270	40	022902	008334



GRATTOIR COUDÉ

GRATTOIR COUDÉ

Scraper, deck / Winkelschaber / Raspador Elevado

D mm	K mm	Alliage / Alloy	
		Al-Br	Be-Cu
300	48	022930	008330

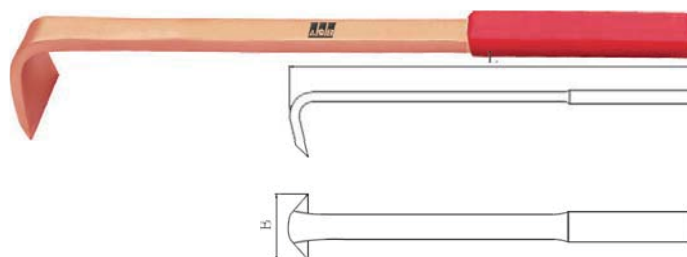

GRATTOIR COUDÉ

GRATTOIR COUDÉ

Scraper, deck / Winkelschaber / Raspador Elevado

D mm	K mm	Alliage / Alloy	
		Al-Br	Be-Cu
380	38	022938	008338

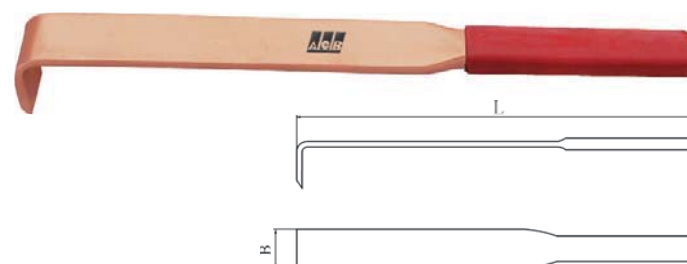

GRATTOIR TRIANGULAIRE

GRATTOIR TRIANGULAIRE

Fiche manquante ...

D mm	K mm	Alliage / Alloy	
		Al-Br	Be-Cu

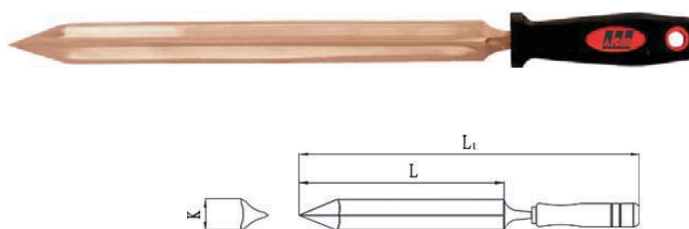



GRATTOIR DE MÉCANICIEN

Scraper, flat / Flachscharer / Raspador Plano

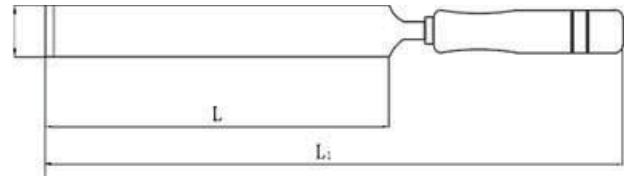

L mm	B mm	H mm	Alliage / Alloy	
			Al-Br	Be-Cu
200	30	325	022720	008320
300	30	430	022730	008230
350	35	490	022735	008235

L mm	B mm	H mm	Alliage / Alloy	
			Al-Br	Be-Cu
350	50	500	022750	008250
400	60	560	022760	008260

GRATTOIR

GRATTOIR

Scraper / Schaber / Raspador

L mm	B mm	Alliage / Alloy	
		Al-Br	Be-Cu
235	76	082201	077801



GRATTOIR LAME CONCAVE

GRATTOIR LAME CONCAVE

Concave blade tank scraper / Schaber, hohlblatt / Raspador hoja concava

B mm	L mm	L ₁ mm	Alliage / Alloy	
			Al-Br	Be-Cu
50	600	120	023429	008929
100	710	120	023430	008930
150	720	120	023435	008935



GRATTOIR LAME CONCAVE

GRATTOIR SANS MANCHE

Scraper, without handle / Schaber, ohne stiel / Raspador, sin mango

B mm	L mm	L ₁ mm	Alliage / Alloy	
			Al-Br	Be-Cu
50	690	90	023407	008907
75	705	100	023409	008909



B mm	L mm	L ₁ mm	Alliage / Alloy	
			Al-Br	Be-Cu
100	720	115	023410	008910
150	765	150	023415	008915

ANTIDÉFLAGRANT
ANTIMAGNÉTIQUE
SAFETYTOOLS

www.adf-safetytools.com

GRATTOIR AVEC LONG MANCHE ET POIGNEE

Scraper, Hand style

L mm	B mm		Alliage / Alloy	
			Al-Br	Be-Cu
480	95	95	060195	060295

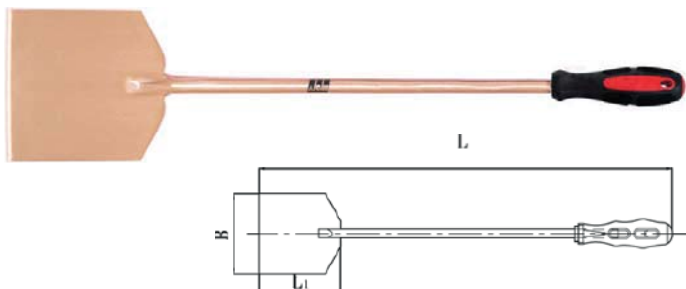

PIC À GRATTOIR

PIC À GRATTOIR

Scraper, pick and scaler / Reinigungswerzeug / Raspador pico

L mm	B mm	Alliage / Alloy	
		Al-Br	Be-Cu
450	75	017501	002601



COUPEAU D'ELECTRICIEN

COUPEAU D'ELECTRICIEN

Electrician Knife

L mm	L ₁ mm	Alliage / Alloy	
		Al-Br	Be-Cu
61	113	056861	056961

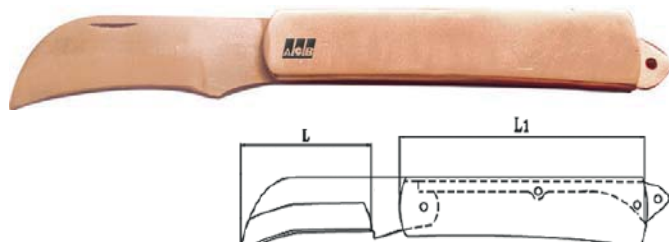

COUPEAU COURBÉ

COUPEAU COURBÉ

Knife, common / Messer / Cuchillo Coün

L mm	L ₁ mm	Alliage / Alloy	
		Al-Br	Be-Cu
80	185	082008	009208
145	250	082001	009201

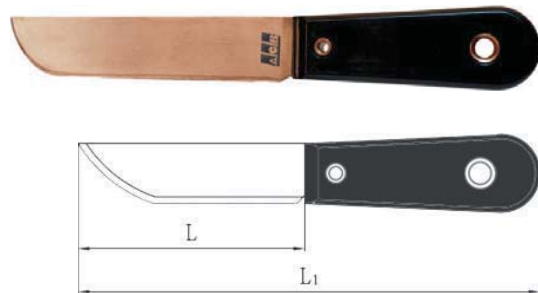

COUPEAU DE VITRIER, LAME RIGIDE

COUPEAU DE VITRIER, LAME RIGIDE

Knife, putty, stiff blade / Spachtel, starres Blatt / Espattuda de Hoja Rigida

K mm	L mm	L ₁ mm	Alliage / Alloy	
			Al-Br	Be-Cu
25	95	200	082108	009008
40	95	200	082109	009009
50	95	200	082110	009010
65	95	200	082112	009012

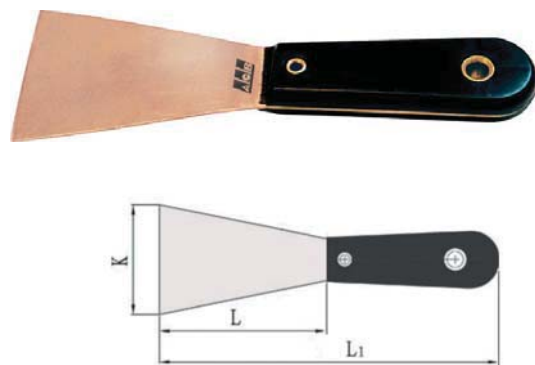



COUPEAU DE VITRIER, LAME RIGIDE

Knife, putty, stiff blade / Spachtel, starres Blatt / Espattuda de Hoja Rigida

K mm	L mm	L ₁ mm	Alliage / Alloy	
			Al-Br	Be-Cu
75	95	200	082128	009028
100	95	200	082130	009030
150	145	250	082132	009032

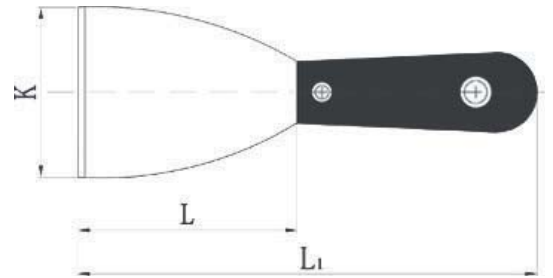

BROSSE À MAIN

BROSSE À MAIN

Brush, flat back / Kastenbürste, Runddraht glatt / Cepillo de Alambre Redonto

L mm	B mm	H mm	Rang	Alliage / Alloy	
				Al-Br	Be-Cu
205	48	41	6*16	-	012401



BROSSE À MANCHE

BROSSE À MANCHE

Brush, curved handle / Handdrahtbürste, runddraht glatt / Cepillo de Alambre Redondo

L mm	B mm	H mm	Rang	Alliage / Alloy	
				Al-Br	Be-Cu
290	29	28	4*16	-	012304



BROSSE À BOUGIES

BROSSE À BOUGIES

Brush, spark-plug cleaning / Zündkerzenbürste, Runddraht glatt / Cepillo para Bujias

L mm	B mm	H mm	Rang	Alliage / Alloy	
				Al-Br	Be-Cu
215	29	15	6*15	-	012310



ANTIDÉFLAGRANT
ANTIMAGNÉTIQUE
SAFETYTOOLS

www.adf-safetytools.com

BALAI DE RUE FIL ROND

Broom round wire / Besen, Runddraht glatt / Escoba, de Alambre Redondo

L mm	Rows	H mm	Alliage / Alloy	
			Al-Br	Be-Cu
310	6*25	55		



BROSSE GOUPIILLON

BROSSE GOUPIILLON

Brush tub / Zylinderbürste draht gewellt / Cepillo de tubo

Ø mm	L1 mm	L mm	Alliage / Alloy	
			Al-Br	Be-Cu
20	100	320		

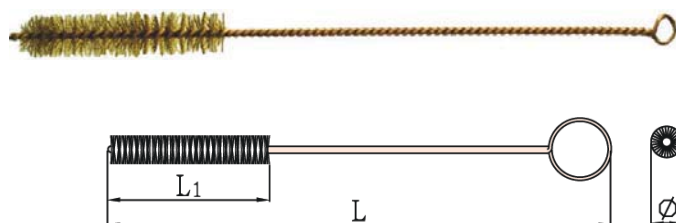

BROSSE CIRCULAIRE FIL EN TRESSE

BROSSE CIRCULAIRE FIL EN TRESSE

Wheel brush, knot wire / Rundbürste, runddraht gezopft / Cepillo circular de alambre redondo rancio

Ø mm	H mm	Ø1 mm	Alliage / Alloy	
			Al-Br	Be-Cu
126	15	14		



BROSSE CIRCULAIRE FIL ONDULE

BROSSE CIRCULAIRE FIL ONDULE

Wheel brush, crimped wire / Rundbürste, runddraht gewellt / Cepillo circular de alambre redondo undulado

Ø mm	H mm	M mm	Alliage / Alloy	
			Al-Br	Be-Cu
126	15	14		

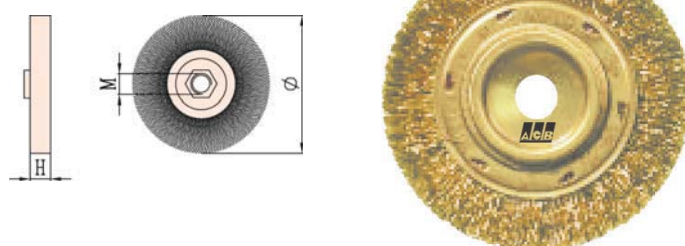



BROSSE PINCEAU

End brush / Pinsebürste / Pincel plano

Ø mm	L1 mm	Ø1 mm	Alliage / Alloy	
			Al-Br	Be-Cu
26	25	6		

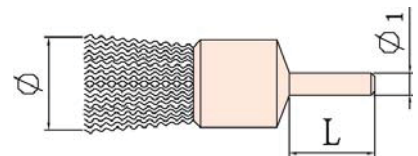

BROSSE À CIRCULAIRE

BROSSE À CIRCULAIRE

Crimped wire wheel brush / Drahtbürste / Cepillo de alambres

Ø mm	H mm	Ø ₁ mm	Alliage / Alloy	
			Al-Br	Be-Cu
75	10	6	012501	012502

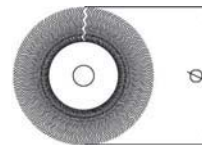
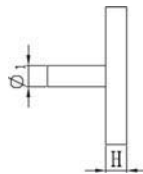

BROSSE FILS ONDULÉS

BROSSE FILS ONDULÉS

Crimped wire cup brush / Drahtbürste / Cepillo de alambres

Ø mm	H mm	M mm	Alliage / Alloy	
			Al-Br	Be-Cu
100	30	14	012530	012531

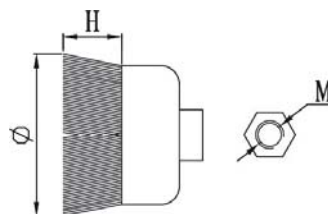

BROSSE FILS TORSADÉS

BROSSE FILS TORSADÉS

Crimped wire cup brush / Drahtbürste / Cepillo de alambres

Ø mm	H mm	Ø ₁ mm	Alliage / Alloy	
			Al-Br	Be-Cu
100	30	14	012534	012535

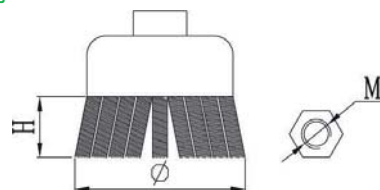

ANTIDÉFLAGRANT
ANTIMAGNÉTIQUE
SAFETYTOOLS

www.adf-safetytools.com

SCIE À MÉTAUX

Hack saw frame / Bügelsäge DIN 6473 / Marco para Sierra de Corte

L mm	D mm	H mm	Alliage / Alloy	
			Al-Br	Be-Cu
500	300	110	017901	003001

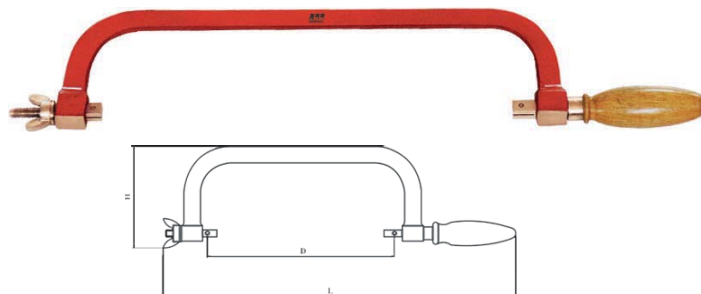

LAME DE SCIE

LAME DE SCIE

Blade, hack saw / Sägeblatt / Hoja de Sierra de Corte

L mm	B mm	Alliage / Alloy	
		Al-Br	Be-Cu
300	12	-	003101



SCIE ÉGOÏNE

SCIE ÉGOÏNE

Hand saw / Handsäge / Serrucho de Mano

S mm	L mm	Alliage / Alloy	
		Al-Br	Be-Cu
370	114	-	003202





LIME CARRÉE

File square / Kalk platz / Lima plaza

L inch	L mm	B mm	Alliage / Alloy
			Be-Cu
8"	200	8	076208
10"	250	10	076210
12"	300	11	076211
14"	350	12	076212

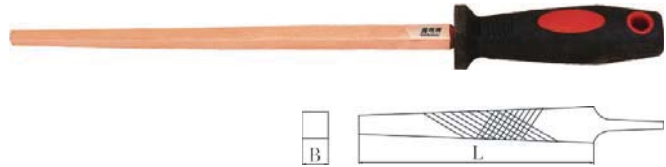

LIME RONDE

LIME RONDE

File round / Kalk runde / Lima vuelta

L inch	L mm	Ø mm	Alliage / Alloy
			Be-Cu
6"	150	6,5	076106
8"	200	7,5	076108
10"	250	8,5	076110
12"	300	9,5	076112
14"	350	10,5	076114

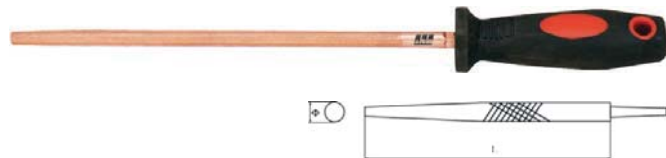

LIME PLATE

LIME PLATE

File flat / Kalk platte / Lima placa

L inch	L mm	B mm	H mm	Alliage / Alloy
				Be-Cu
6"	150	16	4	076006
8"	200	21	4,5	076008
10"	250	25	6	076010
12"	300	30	6,5	076012
14"	350	32	8	076014
16"	400	32	9,5	076016

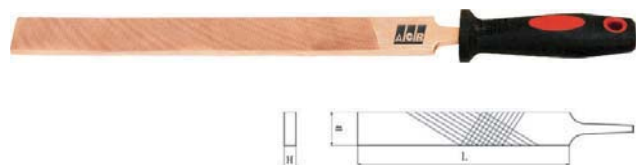

ANTIDÉFLAGRANT
ANTIMAGNÉTIQUE
SAFETYTOOLS

www.adf-safetytools.com

LIME DEMI-RONDE

File half round / Kalk semi runde / Lima media vuelta

L inch	L mm	B mm	H mm	Alliage / Alloy
				Be-Cu
6"	150	22	6	009306
8"	200	23	7	009308
10"	250	26	8	009310
12"	300	28	9	009312
14"	350	30	10	009314



LIME TRIANGULAIRE

LIME TRIANGULAIRE

File triangle / Kalk dreieckige / Lima triangular

L inch	L mm	B mm	Alliage / Alloy
			Be-Cu
8"	200	12	076308
10"	250	13	076310
12"	300	14	076312
14"	350	14	076314

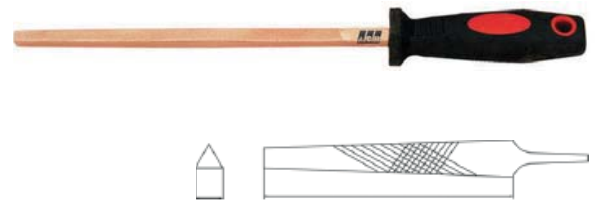

PELLES / PIOCHES / BÈCHES / HOUES / RATEAUX

SHOVELS / RAILROAD PICKS / EDGING SPADES / HOES / RAKES
SCHAUFEL / KREUZHACKE / SPATEN / HAUE / RECHEN
PALA / PICO DE FERROCARRIL / AZADA / AZADON / RASTRILLO



ANTIDÉFLAGRANT
ANTIMAGNÉTIQUE
SAFETYTOOLS

www.adf-safetytools.com

ANTIDÉFLAGRANT
ANTIMAGNÉTIQUE
SAFETYTOOLS

www.adf-safetytools.com

BÊCHE AVEC MANCHE À POIGNÉE

Edging spade with D-handle / Spaten mit D-Stiel, DIN 20127 / Azada de Borde

Dim mm	L mm	Alliage / Alloy	
		Al-Br	Be-Cu
190	285	012905	-

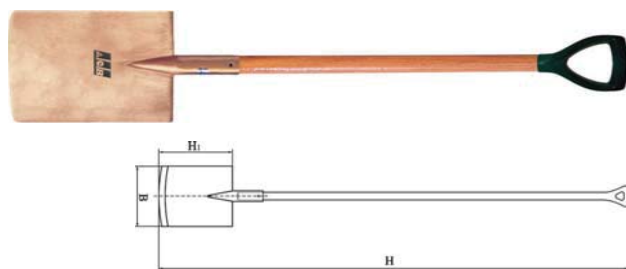

FOURCHE

FOURCHE

Fork / Grabgabel / Horquilla de jardín

L mm	B mm	Alliage / Alloy	
		Al-Br	Be-Cu
327	200	016901	002001

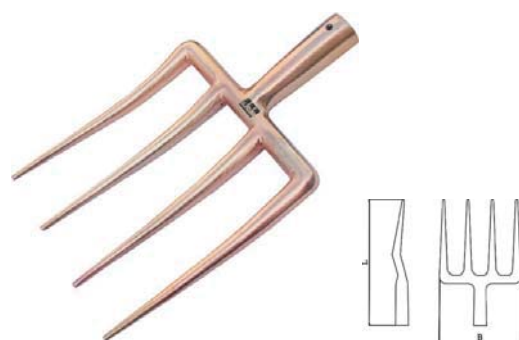

BÊCHE AVEC MANCHE À POIGNÉE

PIOCHE

Railroad pick / Kreuzhacke, DIN 20109 / Pico de Ferrocarril

L mm	H mm	K mm	Kg	Alliage / Alloy	
				Al-Br	Be-Cu
1050	410	56	2	016801	001901
1050	470	56	2,4	016803	001903
1050	560	56	3,3	016805	001905
1050	630	58	4,2	016807	001907
1050	750	60	6	016809	001909

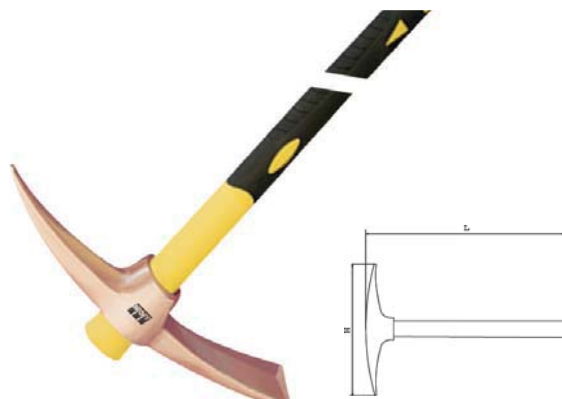

RÂTEAU

RÂTEAU

Rake / Rechen / Rastrillo

L mm	Alliage / Alloy	
	Al-Br	Be-Cu
350	017701	002801

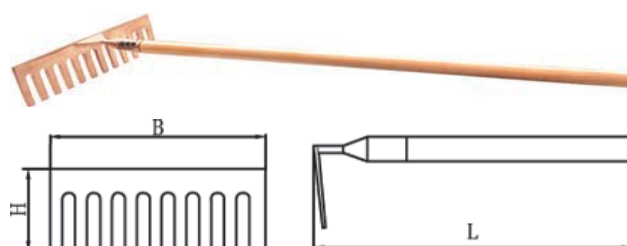



HOUE

Hoe / Haue / Azadon

B mm	H mm	Alliage / Alloy	
		Al-Br	Be-Cu
130	130	017610	060310
200	200	017620	060320



HOUE À MANCHE LONG

HOUE À MANCHE LONG

Garden hoe / Gartenhaue / Azadon de jardin

B mm	H mm	Alliage / Alloy	
		Al-Br	Be-Cu
300	150		

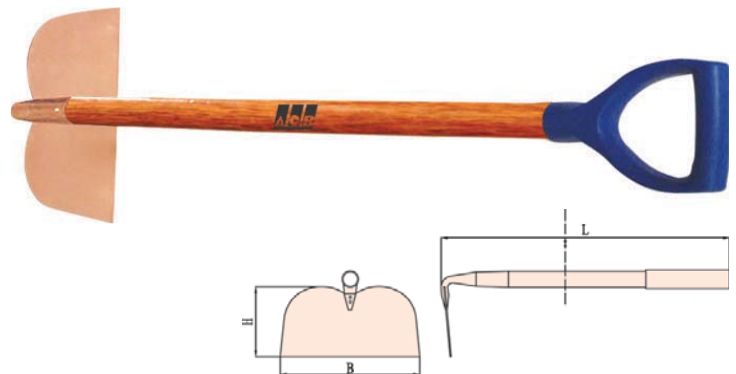

TRUELLE

TRUELLE

Trowel, bricklayer's / Maurerkelle / Palustre para ladrillos

L mm	L ₁ mm	B mm	Alliage / Alloy	
			Al-Br	Be-Cu
335	215	130	-	050000



ANTIDÉFLAGRANT
ANTIMAGNÉTIQUE
SAFETYTOOLS

www.adf-safetytools.com

PELLE CARRÉE, MANCHE À POIGNÉE

Shovel, square edge / Randschaufel, DIN 20123 / Pala de punta cuadrada

L mm	B mm	H mm	Qualité	
			Al-Br	Be-Cu
1040	240	418	081606	077206



PELLE CREUSE, MANCHE À POIGNÉE

PELLE CREUSE, MANCHE À POIGNÉE

Shovel, scoop / Ballastschaufel / Pala cuchara

L mm	B mm	H mm	Qualité	
			Al-Br	Be-Cu
1040	270	520	082705	012705



PELLE DE TERRASSIER, MANCHE À POIGNÉE

PELLE DE TERRASSIER, MANCHE À POIGNÉE

Shovel, round point / Schaufel, Frankfurter form, DIN 20121 / Pala de punta redonda

L mm	B mm	H mm	Qualité	
			Al-Br	Be-Cu
1000	240	420	081805	012806

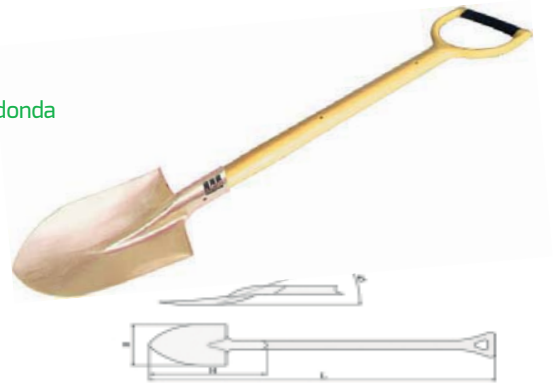

PELLE PLIANTE

PELLE PLIANTE

Folding spade / Faltender spater / Espada que dobla

L mm	B mm	H mm	Qualité	
			Al-Br	Be-Cu
320	180	130	-	013502

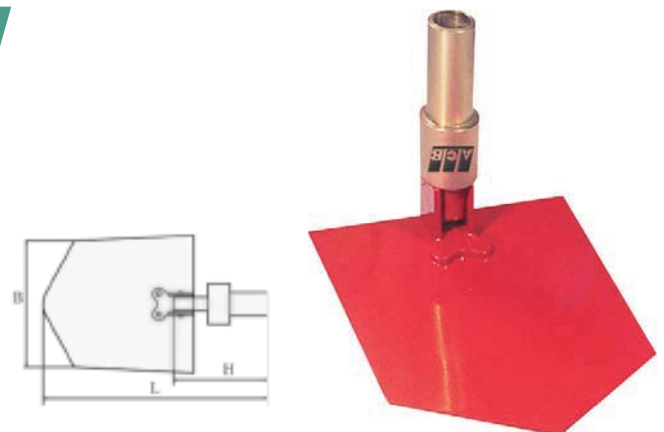

ACCESSOIRES

A DÉFINIR / ---

A DÉFINIR / ---



ANTIDÉFLAGRANT
ANTIMAGNÉTIQUE
SAFETYTOOLS

www.adf-safetytools.com

ANTIDÉFLAGRANT
ANTIMAGNÉTIQUE
SAFETYTOOLS

www.adf-safetytools.com

AIGUILLE D'AUDITION

Hearing Needle

L mm	Ø mm	Alliage / Alloy	
		Al-Br	Be-Cu
250	6		
300	8		
400	7		
600	10		



AIGUILLE

AIGUILLE

Needle

L mm	Ø mm	Alliage / Alloy	
		Al-Br	Be-Cu
180	3		



EXTRACTEURS 3 CROCHETS

EXTRACTEURS 3 CROCHETS

L mm	Alliage / Alloy	
	Al-Br	Be-Cu
100		
150		
200		
350		

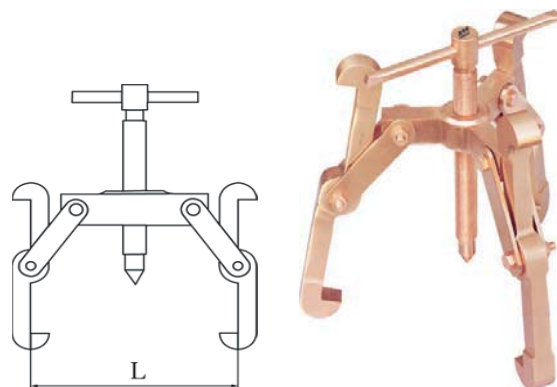

OUVRE TONNEAU A CARBURE

OUVRE TONNEAU A CARBURE

L mm	B mm	Alliage / Alloy	
		Al-Br	Be-Cu
280	53	017401	022501

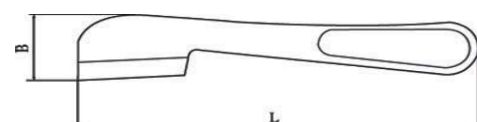



PRESSE SERRE-JOINT

Manquant ...

L mm	H mm	h mm	Alliage / Alloy	
			Al-Br	Be-Cu
210	60	36	021101	006301
250	80	36	021103	006303
290	100	36	021105	006305

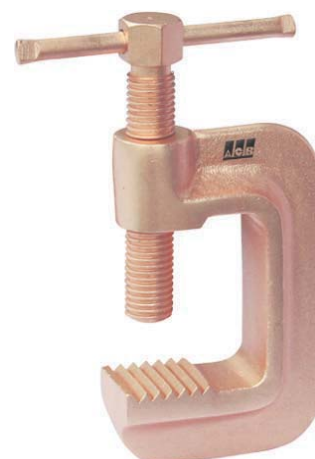
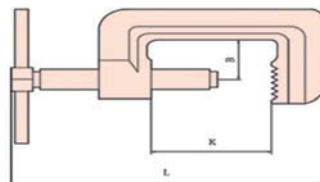

SERRE-JOINTS

SERRE-JOINTS

Screw clamp

B mm	Kmax mm	Alliage / Alloy	
		Al-Br	Be-Cu
120	400	058512	058612



MAILLE

MAILLE

Shackle / Schäkel DIN 82101 / Grillo

Size	K mm	L mm	H mm	Alliage / Alloy	
				Al-Br	Be-Cu
1/2	30	60	40	025605	060405
3/4	37	99	78	025610	060410

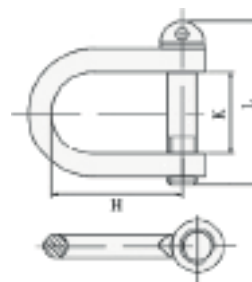
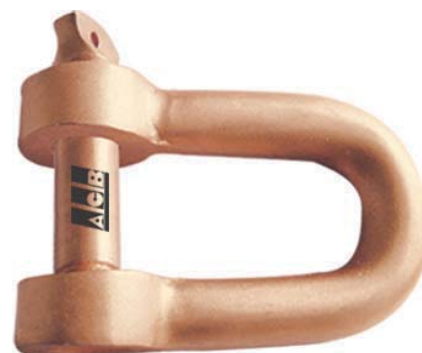

ANTIDÉFLAGRANT
ANTIMAGNÉTIQUE
SAFETYTOOLS

www.adf-safetytools.com

RAMASSE-POUSSIÈRES

Dust pan / Handschaufel / Recogedor

L mm	B mm	H mm	Alliage / Alloy	
			Al-Br	Be-Cu
200	200	50	-	012605

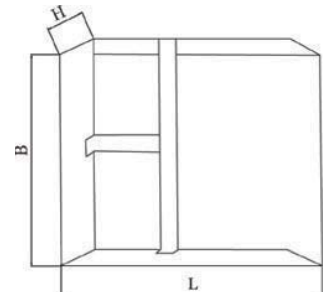

BÊCHE AVEC MANCHE À POIGNÉE

RÉCIPIENT À GRANULÉS ET LIQUIDES

Sugar scoop / Schöpfschaufel / Cuchara Recogedora de Azucar

L mm	H mm	Ø ₁ mm	Ø ₂ mm	Alliage / Alloy	
				Al-Br	Be-Cu
350	90	160	135	-	077102

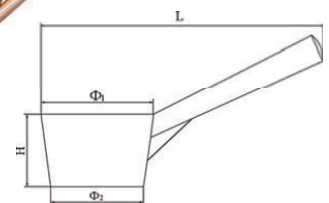

BÊCHE AVEC MANCHE À POIGNÉE

SEAU

Bucket / Eimer / Balde

Ø mm	H mm	Alliage / Alloy	
		Al-Br	Be-Cu
270	248	-	077002

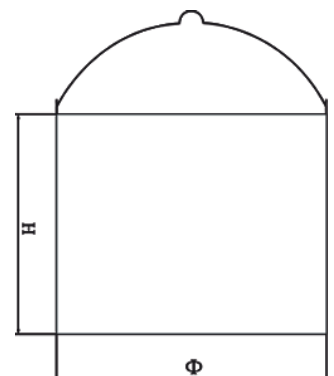



ENTONNOIR

Funnel / Trichter / Embudo

Ø mm	B mm	Alliage / Alloy	
		Al-Br	Be-Cu
160	130	-	029012
160	150	-	029015

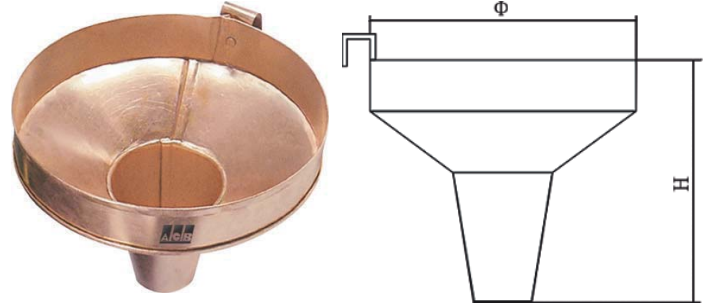

MESURE

MESURE

Measure / Maßnahme / Medida

Ø	B mm	Alliage / Alloy	
		Al-Br	Be-Cu
85	350	-	079402

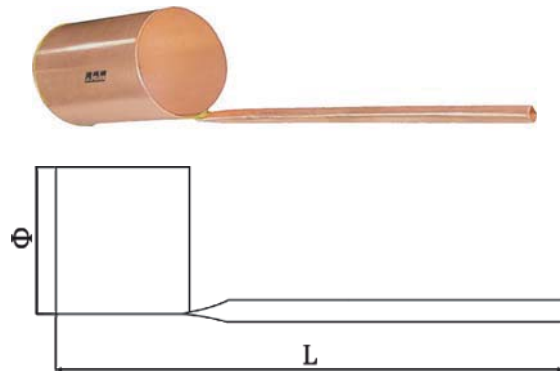

www.adf-safetytools.com

